

A smiling hiker in a blue jacket and orange beanie is climbing a snowy mountain slope. The hiker is wearing a blue puffy jacket, a bright orange knit beanie with a pom-pom, and black gloves. They are using two trekking poles with orange handles and black shafts. The background shows a rugged, snow-covered mountain landscape with rocky outcrops and a clear blue sky. The overall scene is bright and energetic.

KOMPERDELL

www.komperdell.com

WORKBOOK
2020/21



Thomas Dresen
THOMAS DRESSEN
3-TIMES WORLDCUP WINNER

Anna Veith
ANNA VEITH
2-TIMES OVERALL
WORLDCUP WINNER

Henrik Kristoffersen
HENRIK KRISTOFFERSEN
GIANT SLALOM
WORLD CHAMPION

THE CHOICE OF CHAMPIONS

The world's best athletes
trust in Komperdell.

© GEPA-PICTURES



Petra Vlhova
PETRA VLHOVA



Marco Schwarz
MARCO SCHWARZ



Ilka Stuhec
ILKA STUHEC



Hannes Reichelt
HANNES REICHEL

INNOVATION

runs in our blood and a lot has changed since our first aluminum racing poles. But we do not stop here: Our future holds even lighter poles and even better materials, which will enable our athletes to be one step ahead of their opponents.

TEAMWORK WITH OUR ATHLETES

We attach importance to a close cooperation with our top athletes to enhance product development. The poles' low weight and the best possible quality explain their success.

RACING WORLD CUP

We design, develop and
manufacture our own
carbon shafts.



Henrik Kristoffersen

HENRIK KRISTOFFERSEN
1X GIANT SLALOM WORLD CHAMPION
2x OLYMPIC MEDAL WINNER

© GEPA-PICTURES

SOLID SCREW JOINT
for extra tight fit and no twisting
of the punch protection

PUNCH PROTECTION
made of highly resistant,
thermoplastic resin,
absorbs hard impacts

STRAP FASTENING
makes tearing off the
strap nearly impossible

SHRINKING TUBE
for reinforcement of the tube

WORLD CUP EQUIPMENT
highly rigid materials and precise
manufacturing for highest demands

SKICROSS STRAP
with free hands at the starting
block catapulted into the race

CARBON SHAFTS
for zero weight and
maximum performance

BASKETS & TIPS
fixed with extra
tight cement

**NATIONALTEAM
CARBON SLALOM 12,3**

Sizes: 100 - 140 cm
(in 5cm steps)

Features:

- * technical grip with rubber & punch cover World-Cup style
- * race strap
- * carbon, Ø 12,3 mm
- * mini race basket
- * tungsten/carbide flex tip

art. # 147 32 51-48

**NATIONALTEAM
CARBON GS 12,3**

Sizes: 105 - 140 cm
(in 5cm steps)

Features:

- * race grip Duplo
- * race strap
- * carbon, Ø 12,3 mm
- * downhill basket
- * tungsten/carbide flex tip

art. # 147 32 54-48

**NATIONALTEAM CARBON
SKICROSS 12,3 MM**

Sizes: 105 - 140 cm
(in 5cm steps)

Features:

- * race grip Duplo
- * skicross strap
- * carbon, Ø 12,3 mm
- * mini race basket
- * tungsten/carbide flex tip

art. # 147 32 54-48 AW 24

RACING WORLD CUP



Anna Veith
ANNA VEITH
 2-TIMES OVERALL
 WORLD CUP WINNER

© GEPA-PICTURES

RACE GRIP
 offers optimal grip and
 confident grip feeling

BENT CARBON
 with aerodynamic bend
 for maximum speed



**NATIONALTEAM
 CARBON GS BENT**

Sizes: 115 - 140 cm
 (in 5 cm steps)

- Features:**
- * race grip Duplo
 - * race strap
 - * carbon, Ø 16/10 mm, bent
 - * downhill basket
 - * tungsten/carbide flex tip

art. # 148 10 54-48



**NATIONALTEAM
 CARBON SUPER-G**

Sizes: 120 - 140 cm
 (in 5 cm steps)

- Features:**
- * race grip Duplo
 - * race strap
 - * carbon, Ø 16/10 mm, bent
 - * downhill basket
 - * tungsten/carbide flex tip

art. # 148 10 52-48



**NATIONALTEAM
 CARBON DOWNHILL**

Sizes: 120 - 140 cm
 (in 5 cm steps)

- Features:**
- * race grip Duplo
 - * race strap
 - * carbon, Ø 16/10 mm, bent
 - * downhill basket
 - * tungsten/carbide flex tip

art. # 148 10 53-48



**NATIONALTEAM
 PROFI 19 MM**

Sizes: 100 - 135 cm
 (in 5 cm steps)

- Features:**
- * race grip Duplo
 - * race strap
 - * aluminum 7075-T6, Ø 19 mm
 - * mini race basket
 - * tungsten/carbide flex tip

art. # 144 42 01-48

RACING CARBON



PETRA VLHOVA
GIANT SLALOM WORLD CHAMPION

© GEPA-PICTURES

HIGH PERFORMANCE CARBON

We develop our own carbon tubes. Top-quality Japanese carbon fibers in combination with our unique production technique and resins result in top quality carbon poles with breaking points up to 200 kg.



NATIONALTEAM CARBON

Sizes: 110 - 135 cm
(in 5 cm steps)

Features:

- * race grip Duplo
- * powder strap
- * carbon, Ø 13/9 mm
- * mini race basket
- * tungsten/carbide flex tip

art. # 146 42 01-48

JUNIOR-EDITION

The perfect racing pole made of extra light Carbon for tomorrow's winner!



NATIONALTEAM CARBON JUNIOR

Sizes: 85 - 110 cm
(in 5 cm steps)

Features:

- * rubber race grip
- * powder strap
- * carbon, Ø 13/9 mm
- * mini race basket
- * carbide tip

art. # 146 42 02-48

POWDER STRAP

easy to open and close for perfect fit and comfort

RACING ALUMINUM

We are the most successful racing brand in history.



Thomas Dossen

THOMAS DROSSEN
3-TIMES WORLDCUP WINNER

© GEPA-PICTURES

POWDER STRAP
easy to open and close for perfect fit and comfort

SUPER-G POLE
made of extremely strong aluminum 7075-T6 with aerodynamical Super-G bending

HIGH-END ALUMINUM
Ingredients of zinc and magnesium together with a complex alloying technique result in extreme strength, similar to steel.

NATIONALTEAM SUPER-G 18 MM

Sizes: 110 - 135 cm (in 5cm steps)

Features:

- * rubber race grip
- * powder strap
- * aluminum 7075-T6, Ø 18 mm
- * downhill basket
- * tungsten/carbide flex tip

art. # 134 42 02-48

NATIONALTEAM 18 MM

Sizes: 110 - 135 cm (in 5cm steps)

Features:

- * rubber race grip
- * powder strap
- * aluminum 7075-T6, Ø 18 mm
- * mini race basket
- * steel tip

art. # 134 42 01-48

NATIONALTEAM SUPER-G JUNIOR

Sizes: 85 - 115 cm (in 5cm steps)

Features:

- * structure grip PE
- * powder strap
- * aluminum 7075-T6, Ø 16 mm
- * downhill basket
- * carbide tip

art. # 224 42 02-48

NATIONALTEAM JUNIOR

Sizes: 85 - 115 cm (in 5cm steps)

Features:

- * structure grip PE
- * powder strap
- * aluminum 7075-T6, Ø 16 mm
- * mini race basket
- * carbide tip

art. # 224 42 01-48

PROTECTION CARBON

The lightest carbon shin- and elbow guards on the market – perfect protection for every racer.



**INCLUSIVE
TRANSPORT BAG**

LEADING EDGE
provides perfect slap of
the gate outwards



CUSTOMIZED FIT
provides perfect
close fitting

CARBON SHIN-GUARD WORLD CUP

art. # 8122-48 Adult



REINFORCED SURFACE
provides perfect protection
against the gate

**FLEXIBLE
OUTER EDGE**
perfect fit for
forearm and calf

close fitting
with the boot



**REINFORCED
MATERIAL
IN THE CENTER**
perfect protection
against hitting gates



CARBON ELBOW PROTECTION WORLD CUP

art. # 8124-48



RACING PROTECTION



Luca Aerni

LUCA AERNI
GOLD MEDAL IN THE
ALPINE COMBINED EVENT

© GEPA-PICTURES

SEAMS AT THE OUTSIDE
no irritating seams on your fingertips

NON-SLIP PALM
for especially good grip

EXPANDED KNUCKLE PROTECTION
made of Carbon

RACING GLOVE
Sizes: XS - XL
Features:
* real leather
* special thermal insulation
* knuckle protection made of carbon
* shock absorbing foam at finger, thumb and back of the hand
art. # 6501-02

PADDING IN ARMADILLO PRINCIPLE
flexible punch protection

extremely warm & genuine leather

TOUGH-STUFF MATERIAL
extremely abrasion resistant – also used in motorcycling

RACING LOBSTER
Sizes: XS - XL
Features:
* real leather
* special thermal insulation
* knuckle protection made of carbon
* shock absorbing foam at finger, thumb and back of the hand
art. # 6502-02

SHIN GUARD PROFI WORLD CUP
art. # 747-48 Adult
art. # 151-48 Junior

PUNCH PROTECTION WORLD CUP
art. # 156-48
art. # 156-02

PUNCH PROTECTION PROFI
art. # 158-48
art. # 158-02

PUNCH PROTECTION BIG
art. # 153-48

PUNCH PROTECTION SMALL
art. # 152-48

ELBOW PROTECTION WORLD CUP
art. # 130-48 Adult
art. # 129-48 Junior

RACING SUITS

Full body protection for every racer.



ALSO FOR YOUNG RIDERS

SIZE CHART FOR JUNIORS

size	unisex	age
116	XS	6 years
128	S	8 years
140	M	10 years
152	L	12 years

PROTECTION OF UPPER ARM

PROTECTION OF FOREARM

PROTECTION OF THIGH

PROTECTION OF KNEE



PROTECTION OF SHOULDERS

PROTECTION OF SHOULDER BLADE & BACK



EXTRA WARM
extra warm due to thermo fleece lining

FULL PROTECTOR RACE SUIT

Sizes: Adult: XXS - XXL
Junior: 116 - 152

Features:

- * with integrated protector at the back
- * special racing material
- * elastic and breathable
- * integrated protectors at upper arms, forearms, shoulders, hips, tailbone, thigh & knee
- * preshaped cut - adapted to the racing position
- * thumb-loops
- * front zip

art. # 6307-02 Adult
art. # 6308-02 Junior

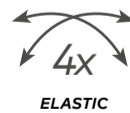

ELASTIC

4-WAY STRETCH MATERIAL
for highest resistance and flexibility



PROTECTION OF UPPER ARM

PROTECTION OF FOREARM

PROTECTION OF THIGH

PROTECTION OF KNEE

ALSO FOR YOUNG RIDERS

SIZE CHART FOR JUNIORS		
size	unisex	age
116	XS	6 years
128	S	8 years
140	M	10 years
152	L	12 years

PROTECTION OF SHOULDERS

EXTRA WARM
extra warm due to thermo fleece lining

PROTECTION OF TAILBONE

4X ELASTIC

4-WAY STRETCH MATERIAL
for highest resistance and flexibility

SLALOM RACE SUIT

Sizes: Adult: XXS - XXL
Junior: 116 - 152

Features:

- * integrated protectors at upper arms, forearms, shoulders, hips, tailbone thigh & knee
- * special racing material
- * elastic and breathable
- * reshaped cut - adapted to the racing position
- * thumb-loops
- * front zip
- * perfect combination with FIS Approved Race Protector Pack (see page 21)

art. # 6303-02 Adult
art. # 6304-02 Junior

RACING PROTECTION



FLEX PACK

Sizes: Adult: XXS - XL
Junior: 128 - 140 - 152

Features:

- * multilayer Cross Flex back-protector made of adaptive dual-density foam, EN-approved 1621-2
- * confirms to FIS regulations
- * anatomic shaped back part
- * new preshaped strap system for best fit - shoulder it like a backpack
- * protector insert visible - part of the design concept
- * ultimate freedom of movement
- * slim kidney belt for perfect fit, adjustable with velcro and plush

art. # 6362-213 Adult
art. # 6363-213 Junior

FULL PROTECTOR SLALOM SHIRT LONG

Sizes: Adult: XS - XL
Junior: 116 - 152

Features:

- * perfect breathability, comfortable to wear
- * multilayer Cross 6.0 back-protector, made of adaptive dual-density foam, EN-approved 1621-2
- * perfect protection of back, shoulders, shoulderblades & arms

art. # 6301-208 Adult
art. # 6302-208 Junior

PROTECTOR SLALOM SHIRT

Sizes: Adult: XS - XL
Junior: 116 - 152

Features:

- * perfect breathability, comfortable to wear
- * body-shape cut
- * multilayer protectors made of dual-density foam
- * perfect protection of shoulders, shoulderblades and arms
- * specially shaped back for perfect combination with the Flex Pack

art. # 6283-02 Adult
art. # 6284-02 Junior



THE MAIN COMPARTMENT
with partitions for goggles, helmet and punch guards



NATIONALTEAM SKI BOOT BAG

- Features:**
- * Ski-boots to be stored either in the main compartment or in the side pockets (dry compartment)
 - * partitions in the main compartment (e.g. for helmet, goggles, punch guards)
 - * adjustable and padded shoulder-straps, straps for chest and waist
 - * back-straps can be stowed away
 - * waterproof bottom construction
 - * measurements 600x500x350 mm
 - * total volume 72 liters

art. # 6503-208

WATERPROOF BOTTOM-CONSTRUCTION

SIDE POCKETS
to store ski-boots or other accessories



BACK-STRAP SYSTEM
can be stowed away



packed size
75x28 cm

expandable on both ends
for 350mm to a total of
2200mm



carry-system can be adjusted to
the individual center of gravity

personalization
is optional

2 straps on the inside
to secure the skis



Expandable in length
for 700mm to a total
of 2200mm

wheels facilitate
the transport

NATIONALTEAM EXPANDABLE POLE & SKI BAG WITH WHEELS

- Features:**
- * capacity for 4 pair of skis plus poles
 - * integrated straps with non-slip fixing
 - * reinforced and padded bottom
 - * integrated wheels
 - * carry-system can be adjusted to the individual center of gravity
 - * total length 1500 mm / 109.2 liters
 - * expandable in length for 700 mm to 2200 mm / 23160.16 liters
 - * packed size 750 mm

art. # 6500-02

NATIONALTEAM EXPANDABLE POLE & SKI BAG

- Features:**
- * capacity for 4 pair of skis plus poles
 - * integrated straps with non-slip fixing
 - * tear-proof and robust
 - * total length 1500 mm / 109.2 liters
 - * expandable on both ends for 350 mm to a total of 2200 mm / 160.16 liters

art. # 6414-02

CHAMP CARBON

Signature race design
on ultralight carbon poles
for every day skiing.



CARBON CHAMPION GREEN HENRIK

Sizes: 110 - 135 cm
(in 5 cm steps)

Features:

- * race grip rubber
- * Comfort Strap
- * carbon, Ø 13 mm
- * mini race basket
- * flex steel tip

art. # 146 23 28-10



CARBON CHAMPION PINK ANNA

Sizes: 110 - 135 cm
(in 5 cm steps)

Features:

- * race grip rubber
- * Comfort Strap
- * carbon, Ø 13 mm
- * mini race basket
- * flex steel tip

art. # 146 23 29-10



CARBON CHAMPION YELLOW VINCENT

Sizes: 110 - 135 cm
(in 5 cm steps)

Features:

- * race grip rubber
- * Comfort Strap
- * aluminum 5083, Ø 18 mm
- * mini race basket
- * steel tip

art. # 146 23 30-10



CARBON CHAMPION RED MARCO

Sizes: 110 - 135 cm
(in 5 cm steps)

Features:

- * race grip rubber
- * Comfort Strap
- * aluminum 5083, Ø 18 mm
- * mini race basket
- * steel tip

art. # 146 23 31-10

CHAMP ALUMINUM



CHAMPION GREEN HENRIK

Sizes: 110 - 135 cm
(in 5 cm steps)

Features:

- * race grip rubber
- * Comfort Strap
- * carbon, Ø 13 mm
- * mini race basket
- * flex steel tip

art. # 132 22 36-02



CHAMPION PINK ANNA

Sizes: 110 - 135 cm
(in 5 cm steps)

Features:

- * race grip rubber
- * Comfort Strap
- * carbon, Ø 13 mm
- * mini race basket
- * flex steel tip

art. # 132 22 37-02



CHAMPION YELLOW VINCENT

Sizes: 110 - 135 cm
(in 5 cm steps)

Features:

- * race grip rubber
- * Comfort Strap
- * aluminum 5083, Ø 18 mm
- * mini race basket
- * steel tip

art. # 132 22 38-02



CHAMPION RED MARCO

Sizes: 110 - 135 cm
(in 5 cm steps)

Features:

- * race grip rubber
- * Comfort Strap
- * aluminum 5083, Ø 18 mm
- * mini race basket
- * steel tip

art. # 132 22 40-02



CLOUD SERIES

The lightest carbon poles – 40% lighter

1

CARBON

The lightest alpine poles in the world – 40% lighter compared to regular carbon poles. Komperdell is the only manufacturer with an in-house carbon and carbon pole production.

2

EXTREMELY LIGHT

You will feel immediately what makes this pole so unique – extreme lightness, combined with a fantastic swing momentum!

3

NOBLE APPEARANCE

The poles highlight every outfit with their pure design, which makes every carbon fibre visible. Available in three noble colour combinations.



ALPINE CLOUD

The lightest alpine poles on the market – 40 % less weight



GRIP MADE OF GENUINE LEATHER

3 YEAR SERVICE

SHEER BAMBOO VENEER
on carbontube

POWERLOCK 3.0
highly rigid, anodized
aluminum for maximum
holding power!

CARBON CLOUD

Sizes: 110 - 135 cm
(in 5cm steps)

Features:

- * Foam Pistol grip
- * Comfort Padded Strap
- * Carbon Cloud Ultralight, Ø 16 mm
- * mini UL basket
- * Aluminum tip

- art. # 148 23 24-10 dark knight
- art. # 148 23 28-55 white knight
- art. # 148 23 25-10 snow rose
- art. # 148 32 01-126 rose gold

CARBON CLOUD BAMBOO VARIO

Sizes: adjustable from 110 - 145 cm

Features:

- * leather grip
- * leather strap with embossed logo
- * 2-sections:
upper part: carbon enhanced with bamboo, Ø 16 mm
lower part: carbon, Ø 14 mm
- * Powerlock 3.0 mechanism
- * regular UL basket
- * Aluminum tip

art. # 175 22 15-10

CARBON CLOUD BAMBOO

Sizes: 110 - 135 cm
(in 5cm steps)

Features:

- * leather grip
- * leather strap with embossed logo
- * carbon featherlight, Ø 16 mm
- * enhanced with bamboo
- * regular UL basket
- * Aluminum tip

art. # 148 22 20-10

ALPINE PURE

Pure – slim, ultralight carbon shafts in a clean & puristic design.



CARBON PURE BLACK

Sizes: 110 - 135 cm
(in 5 cm steps)

Features:

- * Foam Pistol grip
- * Comfort Padded Strap
- * carbon, Ø 13 mm
- * Mini UL bakset
- * aluminum Tip

art. # 146 22 18-10



CARBON PURE PEARL

Sizes: 110 - 135 cm
(in 5 cm steps)

Features:

- * Foam Pistol grip
- * Comfort Padded Strap
- * carbon, Ø 13 mm
- * Mini UL bakset
- * aluminum Tip

art. # 146 22 19-55



CARBON PURE ROSEGOLD

Sizes: 110 - 135 cm
(in 5 cm steps)

Features:

- * Foam Pistol grip
- * Comfort Padded Strap
- * carbon, Ø 13 mm
- * Mini UL bakset
- * aluminum Tip

art. # 146 32 01-126

ALPINE BOOSTER

Light, slim & fast. Designed for the athletic skier.

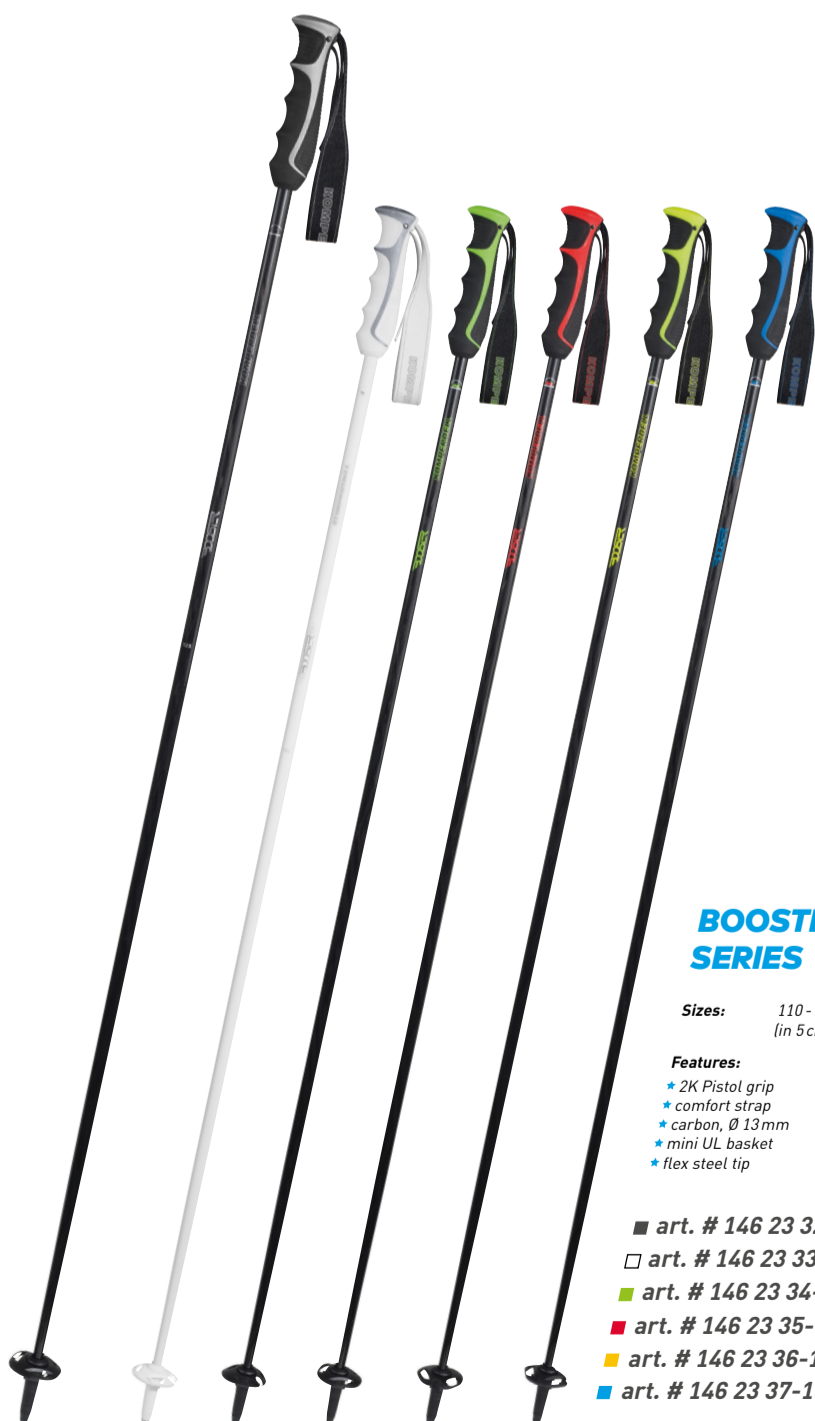

BOOSTER CARBON SERIES

Sizes: 110 - 135 cm
(in 5 cm steps)

Features:

- * 2K Pistol grip
- * comfort strap
- * carbon, Ø 13 mm
- * mini UL basket
- * flex steel tip

- art. # 146 23 32-10 black
- art. # 146 23 33-01 white
- art. # 146 23 34-10 neon green
- art. # 146 23 35-10 infrared
- art. # 146 23 36-10 yellow
- art. # 146 23 37-10 blue



BOOSTER ALLOY SERIES

Sizes: 110 - 135 cm
(in 5 cm steps)

Features:

- * 2K Pistol grip
- * comfort strap
- * aluminum, Ø 16 mm
- * mini UL basket
- * flex steel tip

- art. # 138 23 82-12 black
- art. # 138 23 83-01 white
- art. # 138 23 79-02 green
- art. # 138 23 80-02 infrared
- art. # 138 23 81-02 yellow

ALPINE BLAZER



BLAZER SERIES

Sizes: 110 - 135 cm
(in 5 cm steps)

Features:

- * race grip PU soft
- * system strap
- * aluminum 5086, Ø 18 mm
- * mini UL basket
- * steel tip

- art. # 132 22 41-12 black
- art. # 132 22 42-48 green
- art. # 132 22 43-03 red
- art. # 132 22 44-04 blue

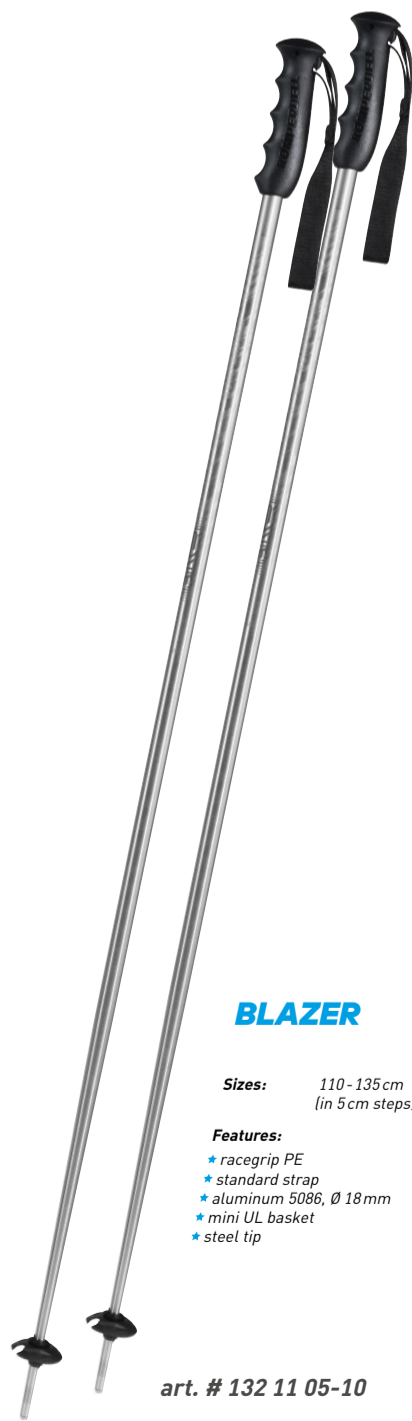

BLAZER

Sizes: 110 - 135 cm
(in 5 cm steps)

Features:

- * racegrip PE
- * standard strap
- * aluminum 5086, Ø 18 mm
- * mini UL basket
- * steel tip

art. # 132 11 05-10



FUNNEL
TO FILL

ALPINE SCHNAPSPOLE

Sizes: 110 - 135 cm
(in 5 cm steps)

Features:

- * inner tube for Schnaps funnel included
- * volume: approx. 0,2l /pole
- * PE-grip with inner tube
- * standard strap
- * aluminum 7075, Ø 19 mm
- * mini UL basket
- * steel tip

art. # 144 93 03-02

ALPINE JUNIOR

Our Smash Series – adjustable from 80 to 105 cm. The pole that grows with your child.



THE SET FOR BEGINNERS
perfect for those first attempts at skiing



SMASH SERIES

Sizes: adjustable from 80 - 105 cm

Features:

- * PU grip junior
- * standard strap
- * Twist Lock system
- * 2-sections: aluminum 7075, Ø 16/14 mm
- * racing basket vario
- * steel tip

- art. # 164 32 01-48 green
- art. # 164 32 02-03 red
- art. # 164 32 03-14 pink

TWISTLOCK MECHANISM
Due to the easy adjustable mechanism the length can be adjusted individually to your child

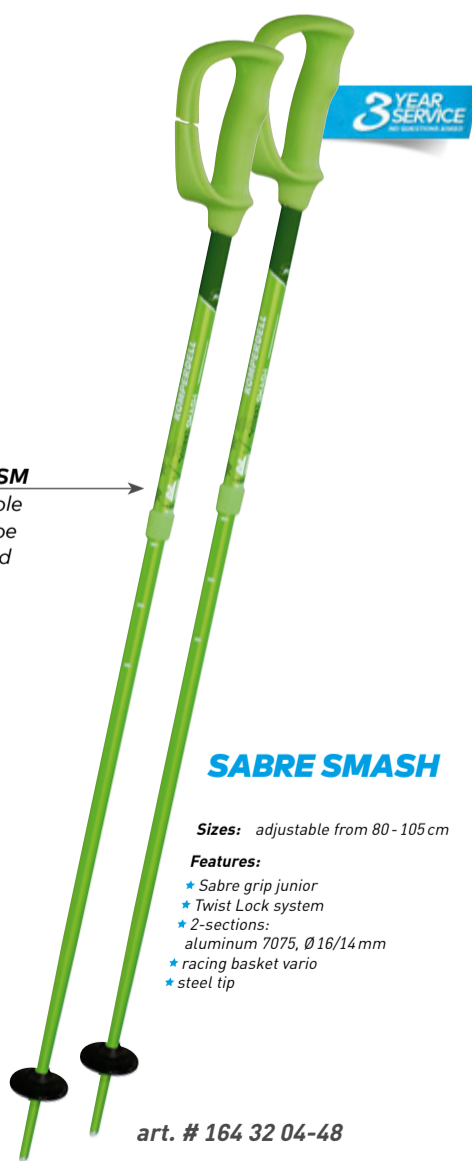

SABRE SMASH

Sizes: adjustable from 80 - 105 cm

Features:

- * Sabre grip junior
- * Twist Lock system
- * 2-sections: aluminum 7075, Ø 16/14 mm
- * racing basket vario
- * steel tip

art. # 164 32 04-48

KIDS SKI-SET

Sizes: 60 cm
70 cm

- * skiset for beginners
- * available in two lengths

- art. # 201-115 Spike Boys
- art. # 201-116 Lucy Girls

ALPINE CHAMP

The Champ Junior Series – for future champions.



CHAMP JUNIOR SUPER-G HENRIK

Sizes: 70 - 105 cm
(in 5 cm steps)

Features:

- * race grip junior
- * standard strap
- * aluminum 5086, Ø 16 mm, bent
- * mini race basket
- * steel tip

art. # 221 22 05-02



CHAMP JUNIOR SUPER-G ANNA

Sizes: 70 - 105 cm
(in 5 cm steps)

Features:

- * race grip junior
- * standard strap
- * aluminum 5086, Ø 16 mm, bent
- * mini race basket
- * steel tip

art. # 221 22 06-02



CHAMP JUNIOR HENRIK

Sizes: 70 - 105 cm
(in 5 cm steps)

Features:

- * race grip junior
- * standard strap
- * aluminum 5086, Ø 14 mm
- * mini race basket
- * steel tip

art. # 211 22 12-02



CHAMP JUNIOR ANNA

Sizes: 70 - 105 cm
(in 5 cm steps)

Features:

- * race grip junior
- * standard strap
- * aluminum 5086, Ø 14 mm
- * mini race basket
- * steel tip

art. # 211 22 13-02



CHAMP JUNIOR ALICE

Sizes: 70 - 105 cm
(in 5 cm steps)

Features:

- * race grip junior
- * standard strap
- * aluminum 5086, Ø 14 mm
- * mini race basket
- * steel tip

art. # 211 22 14-02



SABRE GRIP
safety grip
without strap



GREEN RUSH

Sizes: 70 - 105 cm
(in 5 cm steps)

Features:

- * Sabre grip junior
- * aluminum 5083, Ø 14 mm
- * racing basket
- * steel tip

art. # 211 22 07-48



BRIGHT YELLOW

Sizes: 70 - 105 cm
(in 5 cm steps)

Features:

- * race grip junior
- * junior strap
- * aluminum 5083, Ø 14 mm
- * racing basket
- * steel tip

art. # 211 33 05-15



REALLY PINK

Sizes: 70 - 105 cm
(in 5 cm steps)

Features:

- * race grip junior
- * junior strap
- * aluminum 5083, Ø 14 mm
- * racing basket
- * steel tip

art. # 211 22 08-28



EVERGREEN

Sizes: 70 - 105 cm
(in 5 cm steps)

Features:

- * race grip junior
- * junior strap
- * aluminum 5083, Ø 14 mm
- * racing basket
- * steel tip

art. # 211 22 09-48

ALPINE JUNIOR

With our junior poles we stand for colourful designs in a unique high-quality optic.



BLUE BOOST

Sizes: 70 - 105 cm
(in 5 cm steps)

- Features:**
- * race grip junior
 - * junior strap
 - * aluminum 5083, Ø14 mm
 - * racing basket
 - * steel tip

art. # 211 22 10-04



RED PEAK

Sizes: 70 - 105 cm
(in 5 cm steps)

- Features:**
- * race grip junior
 - * junior strap
 - * aluminum 5083, Ø14 mm
 - * racing basket
 - * steel tip

art. # 211 22 11-03



CHALLENGER

Sizes: 70 - 105 cm
(in 5 cm steps)

- Features:**
- * junior Jet grip
 - * junior strap
 - * aluminum 5083, Ø14 mm
 - * racing basket
 - * steel tip

art. # 211 11 03-10

NORDIC XC CX-80

The lightest, stiffest carbon poles for maximum speed.



BIATHLON STRAP
sold separately

CX-80
our lightest and stiffest carbon shafts

NORDIC CX-80 NATIONAL TEAM

Sizes: individually adapted
140/150/160/170/180 cm

Features:

- * especially nonslip Nordic 2K cork grip
- * Click-in strap 2.0
- * carbon, Ø 16 mm
- * weight 80 grams/1500 mm/bending 15 mm
- * Nordic track UL basket
- * tungsten/carbide tip

art. # 520 23 11-10

NORDIC CX-80 TRACK

Sizes: 120 - 180 cm
(in 5 cm steps)

Features:

- * ultralight Nordic EVA grip
- * Click-in strap 2.0
- * carbon, Ø 16 mm
- * weight 80 grams/1500 mm/bending 15 mm
- * Nordic track UL basket
- * tungsten/carbide tip

art. # 520 23 12-10

Rembrandtin

SIZE CHART FOR SKATING & RACING

Person	Person
140 cm	120 cm
145 cm	125 cm
150 cm	130 cm
155 cm	135 cm
160 cm	140 cm
165 cm	145 cm
170 cm	150 cm
175 cm	155 cm
180 cm	160 cm
185 cm	165 cm
190 cm	170 cm
195 cm	175 cm
200 cm	180 cm



NORDIC XC CX-100

Click-In 2.0 – easiest handling combined with an ergonomically perfect strap.



NATURAL CORK GRIP
sweat absorbing and light

EVA FOAM GRIP
the lightest grip in our program

BIATHLON STRAP
sold separately

EXTRA STIFF CX-100 SHAFT
improved transmission of force

SIZE CHART FOR SKATING & RACING

Person	Stick
140 cm	120 cm
145 cm	125 cm
150 cm	130 cm
155 cm	135 cm
160 cm	140 cm
165 cm	145 cm
170 cm	150 cm
175 cm	155 cm
180 cm	160 cm
185 cm	165 cm
190 cm	170 cm
195 cm	175 cm
200 cm	180 cm

NORDIC CX-100 CORK

Sizes: 120 - 180 cm
(in 5 cm steps)

Features:

- * especially nonslip Nordic 2K cork grip
- * Click-in strap 2.0
- * carbon, Ø 16 mm
- * weight 100g/1500mm/bending 17.5mm
- * Nordic trail UL basket
- * tungsten/carbide tip

art. # 520 23 13-10

NORDIC CX-100 FOAM

Sizes: 120 - 180 cm
(in 5 cm steps)

Features:

- * ultralight Nordic EVA grip
- * Click-in strap 2.0
- * carbon, Ø 16 mm
- * weight 100g/150cm/bending 17.5mm
- * Nordic trail UL basket
- * tungsten/carbide tip

- art. # 520 23 14-10 yellow
- art. # 520 23 15-10 red
- art. # 520 23 16-10 pink

NORDIC CX-100 SPORT

Sizes: 120 - 180 cm
(in 5 cm steps)

Features:

- * especially nonslip Nordic 2K rubber grip
- * Click-in strap 2.0
- * carbon, Ø 16 mm
- * weight 100g/1500mm/bending 17.5mm
- * Nordic trail UL basket
- * tungsten/carbide tip

- art. # 520 23 17-10 yellow
- art. # 520 23 18-10 red
- art. # 520 23 19-10 blue
- art. # 520 23 20-10 pink

NORDIC XC CX-130



2K RUBBER GRIP
slip proof

BIATHLON STRAP
sold separately

CX-130
our basic carbon shaft

NORDIC CX-130 TRACK

- Sizes:** 120 - 180 cm
(in 5 cm steps)
- Features:**
- * especially nonslip Nordic 2K rubber grip
 - * Click-in strap 2.0
 - * carbon, Ø 16 mm
 - * weight 130g/1500mm/bending 20 mm
 - * Nordic trail UL basket
 - * tungsten/carbide tip

■ art. # 520 23 21-10 yellow
■ art. # 520 23 22-10 red

NORDIC TI-150 FOAM

- Sizes:** 120 - 170 cm
(in 5 cm steps)
- Features:**
- * ultralight Nordic EVA grip
 - * Click-in strap 2.0
 - * aluminum 7075-T6, Ø 16 mm
 - * Nordic trail UL basket
 - * tungsten/carbide tip

art. # 524 23 11-02

SIZES CHART FOR SKATING & RACING

Person	Person
140 cm	120 cm
145 cm	125 cm
150 cm	130 cm
155 cm	135 cm
160 cm	140 cm
165 cm	145 cm
170 cm	150 cm
175 cm	155 cm
180 cm	160 cm
185 cm	165 cm
190 cm	170 cm
195 cm	175 cm
200 cm	180 cm

NORDIC XC VARIO

Designed to be used in the backcountry.



NORDIC ADVENTURE VARIO

Sizes: adjustable from 110 - 155 cm

- Features:
- * Nordic foam grip
 - * padded Nordic strap
 - * 2-sections: aluminum 7075, Ø 18/16 mm
 - * Powerlock 3.0 mechanism
 - * BC Nordic basket
 - * Nordic steel tip

art. # 184 23 64-02



NORDIC ADVENTURE

Sizes: 120 - 160 cm (in 5 cm steps)

- Features:
- * Nordic foam grip
 - * padded Nordic strap
 - * aluminum 5083, Ø 16 mm
 - * BC Nordic basket
 - * Nordic steel tip

art. # 522 23 10-02

SIZE CHART FOR CLASSIC & TOURING

Person	Stick
140 cm	110 cm
145 cm	115 cm
150 cm	120 cm
155 cm	125 cm
160 cm	130 cm
165 cm	135 cm
170 cm	140 cm
175 cm	145 cm
180 cm	150 cm
185 cm	155 cm
190 cm	160 cm
195 cm	165 cm
200 cm	170 cm



NORDIC CLASSIC

Sizes: Adult: 120 - 160 cm
Junior: 90 - 115 cm (in 5 cm steps)

- Features:
- * Nordic XC grip
 - * Nordic classic strap
 - * aluminum 5083, Ø 16 mm
 - * XC standard basket
 - * steel tip

art. # 522 11 02-10 Adult
art. # 222 11 21-10 Junior



RENTAL CARBON

High quality carbon shafts –
2-season breakage warranty.

➔ **THE MOST COMPREHENSIVE RENTAL PROGRAM KOMPERDELL HAS EVER PRESENTED**
We offer you the right poles, protectors and snowshoes, simply the optimal rental product.

➔ **INDIVIDUAL LOGO-PRINTS**
We can personalize and print personal logos on the poles, protectors and snowshoes even when only small quantities are ordered.

➔ **OUR SERVICE AND WARRANTY-ADJUSTMENTS ARE THE BEST**
As we are convinced of the quality of our products, we grant you a **2-season breakage warranty** on all carbon poles.

COLOUR CODE VIA POLE TIPS

a different colour per length (sizes in cm)

70	75	80	85	90
95	100	105	110	115
120	125	130	135	

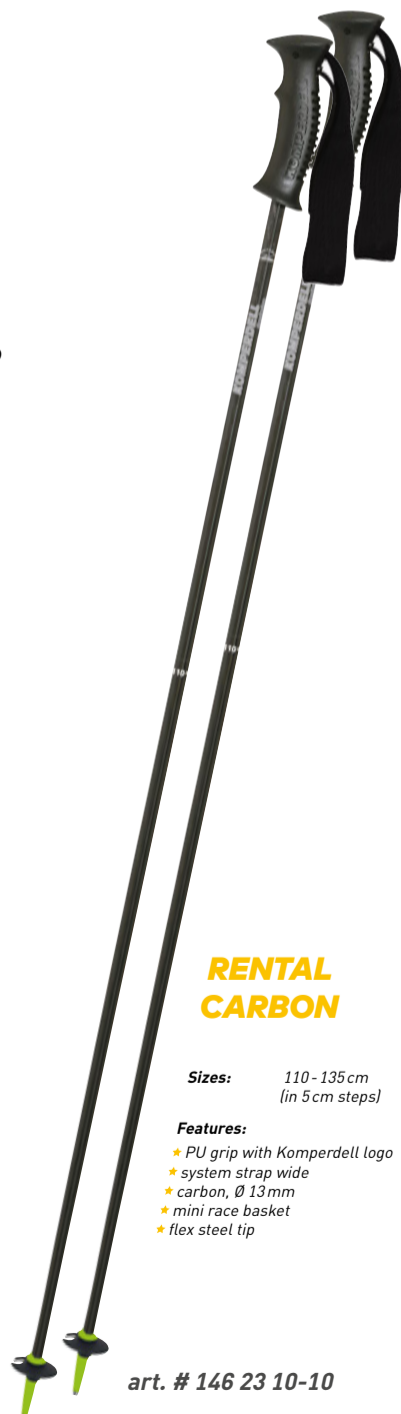

RENTAL CARBON

Sizes: 110 - 135 cm
(in 5 cm steps)

Features:

- ★ PU grip with Komperdell logo
- ★ system strap wide
- ★ carbon, Ø 13mm
- ★ mini race basket
- ★ flex steel tip

art. # 146 23 10-10

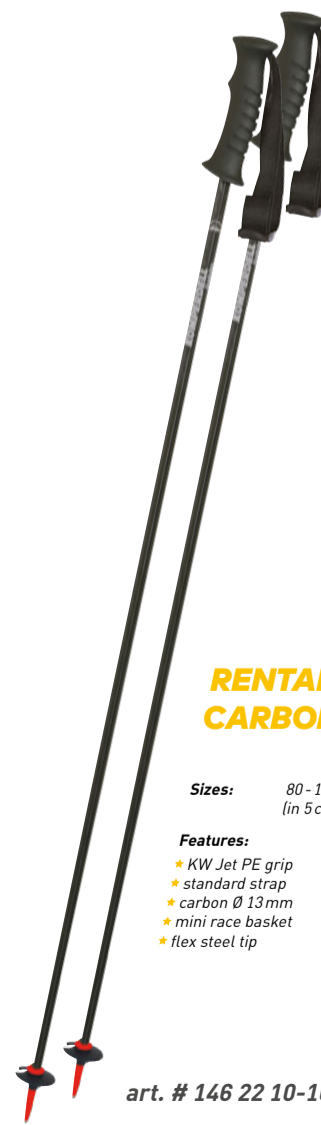

RENTAL CARBON JUNIOR

Sizes: 80 - 105 cm
(in 5 cm steps)

Features:

- ★ KW Jet PE grip
- ★ standard strap
- ★ carbon Ø 13mm
- ★ mini race basket
- ★ flex steel tip

art. # 146 22 10-10

OPTIONAL GRIPS:



EVA FOAM GRIP

art. # 847-02



LIGHTNING DUPLO GRIP

art. # 8047-110

RENTAL ALUMINUM

Telescopic poles ensure that you will always have the correct size in stock for your customers.



COLOUR CODE VIA POLE TIPS

a different colour per length (sizes in cm)

70	75	80	85	90
95	100	105	110	115
120	125	130	135	



RENTAL VARIO

Sizes: adjustable from: 105 - 135 cm

Features:

- ★ PU grip with Komperdell logo
- ★ system strap wide
- ★ aluminum 7075-T6, Ø 18/16 mm
- ★ Twist Lock system
- ★ mini race basket
- ★ steel tip

art. # 184 22 08-02



RENTAL VARIO JUNIOR

Sizes: adjustable from: 80 - 105 cm

Features:

- ★ KW Jet PE grip
- ★ standard strap
- ★ aluminum 7075-T6, Ø 18/16 mm
- ★ Twist Lock system
- ★ mini race basket
- ★ steel tip

art. # 164 22 02-02



RENTAL SOFT CLEAR THERMO

Sizes: 110 - 135 cm (in 5 cm steps)

Features:

- ★ PU soft grip
- ★ system strap wide
- ★ aluminum 7075-T6, Ø 19 mm
- ★ thermo coated
- ★ mini race basket
- ★ steel tip

art. # 144 23 09-10



RENTAL JUNIOR

Sizes: 70 - 105 cm (in 5 cm Steps)

Features:

- ★ KW Jet PE grip
- ★ junior strap
- ★ aluminum 5083, Ø 16 mm
- ★ mini race basket
- ★ steel tip

art. # 221 23 09-10



NORDIC ADVENTURE VARIO

Sizes: adjustable from 110 - 155 cm

Features:

- ★ Nordic foam grip
- ★ padded Nordic strap
- ★ 2-sections: aluminum 7075, Ø 18/16 mm
- ★ Powerlock 3.0 mechanism
- ★ BC Nordic basket
- ★ Nordic steel tip

art. # 184 23 64-02

RENTAL SNOWSHOES

Light, solid quality snowshoes with great traction.



POWDER TRAIL 2

Size: packed size: 84 cm adjustable from 105 - 145 cm

Features:

- ★ EVA foam grip
- ★ system strap wide
- ★ 2-sections: aluminum 7075-T6, Ø 18/16mm
- ★ Powerlock 3.0 mechanism
- ★ vario winter basket
- ★ vario tungsten/carbide flex tip

art. # 184 23 54-10

84 cm



TRAILMASTER SNOWSHOE

Sizes: T25 - up to 100 kg (baggage included)
T30 - up to 120 kg (baggage included)

Features:

- ★ extra tough and snow-repellent Hypalon decking
- ★ light, anodized aluminum frame
- ★ steel crampons made of stainless steel, placed underneath ball and heel provide perfect traction
- ★ fast-click bindings, stable strap system, suitable for any shoe size and normal outdoor shoe wear, extra firm hold
- ★ heel lift

■ art. # 6366-10 T25

■ art. # 6365-10 T30



TRAILBLAZER SNOWSHOE

Sizes: T22 - up to 80 kg (baggage included)

Features:

- ★ extra tough and snow-repellent Hypalon decking
- ★ light, anodized aluminum frame
- ★ steel crampons made of stainless steel, placed underneath ball and heel provide perfect traction
- ★ fast-click bindings, stable strap system, suitable for any shoe size and normal outdoor shoe wear, extra firm hold
- ★ heel lift

art. # 6367-10 T22



RENTAL PROTECTION

Certified according to EN 1621-2, multiple impact protection.
Pro Vest



CONFIRMS TO FIS REGULATIONS



FLEX PACK

Sizes: Adult: XXS - XL
Junior: 128 - 140 - 152

- Features:**
- * multilayer Cross Flex back-protector made of adaptive dual-density foam, EN-approved 1621-2
 - * confirms to FIS regulations
 - * anatomic shaped back part
 - * new preshaped strap system for best fit – shoulder it like a backpack
 - * protector insert visible - part of the design concept
 - * ultimate freedom of movement
 - * slim kidney belt for perfect fit, adjustable with velcro and plush

art. # 6362-213 Adult
art. # 6363-213 Junior

BALLISTIC VEST JUNIOR

Sizes: 116 - 152

- Features:**
- * multilayer Cross 6.0 Junior back protector made of adaptive dual-density foam, EN-approved 1621-2
 - * 360° all around protection - top protection values
 - * light and flexible

- art. # 6321-202 orange
- art. # 6321-209 pink
- art. # 6321-208 lime



CARBON SNOWSHOES

The world's first
full carbon snowshoe.

100% CARBON

50% lighter – only 593 grams

CARBON AIR FRAME

lightest hollow construction

PURE CARBON

completely made in one piece

LIVE ACTION HINGE

adds a spring to your step

AGGRESSIVE STEEL CLAWS DIRECTLY INTEGRATED INTO THE FRAME

give you tons of traction

To save up half the weight on a snowshoe, we not only had to change from aluminum to carbon but we had to completely rethink the way how snowshoes are built. Conventional snowshoes always consist of frame with a separate decking. For our carbon snowshoe both, frame and decking, are laminated in one single step. This made our snowshoe much lighter and stronger. Having half the weight on your feet makes all the difference – each step becomes so much easier you will find it hard to believe, you have to feel it.

SNOWSHOE CARBON

50% less weight and incredible traction on ice and hard packed snow.



EASY STEP-IN BINDING
guarantees quick entry, firm seat, nonetheless comfortable, not constricting fit



3 YEAR SERVICE

CARBON AIR FRAME 25

Sizes: S, M, L

Features:

- * integral built carbon decking
- * especially light, hollow-core carbon frame
- * ice-rail claws for optimal traction
- * heel lift
- * Easy step-in binding with quick-fastener, fitting all sizes and types of boots and offering perfect hold

art. # 6508-10



3 YEAR SERVICE

COMPOSITE AIR FRAME

Sizes: S, M, L

Features:

- * integral built carbon decking
- * especially light, hollow-core carbon frame
- * ice-rail claws for optimal traction
- * heel lift
- * Easy step-in binding with quick-fastener, fitting all sizes and types of boots and offering perfect hold

art. # 6368-10

FREERIDE FATSO

FATSO - the iconic, true
freeride pole.

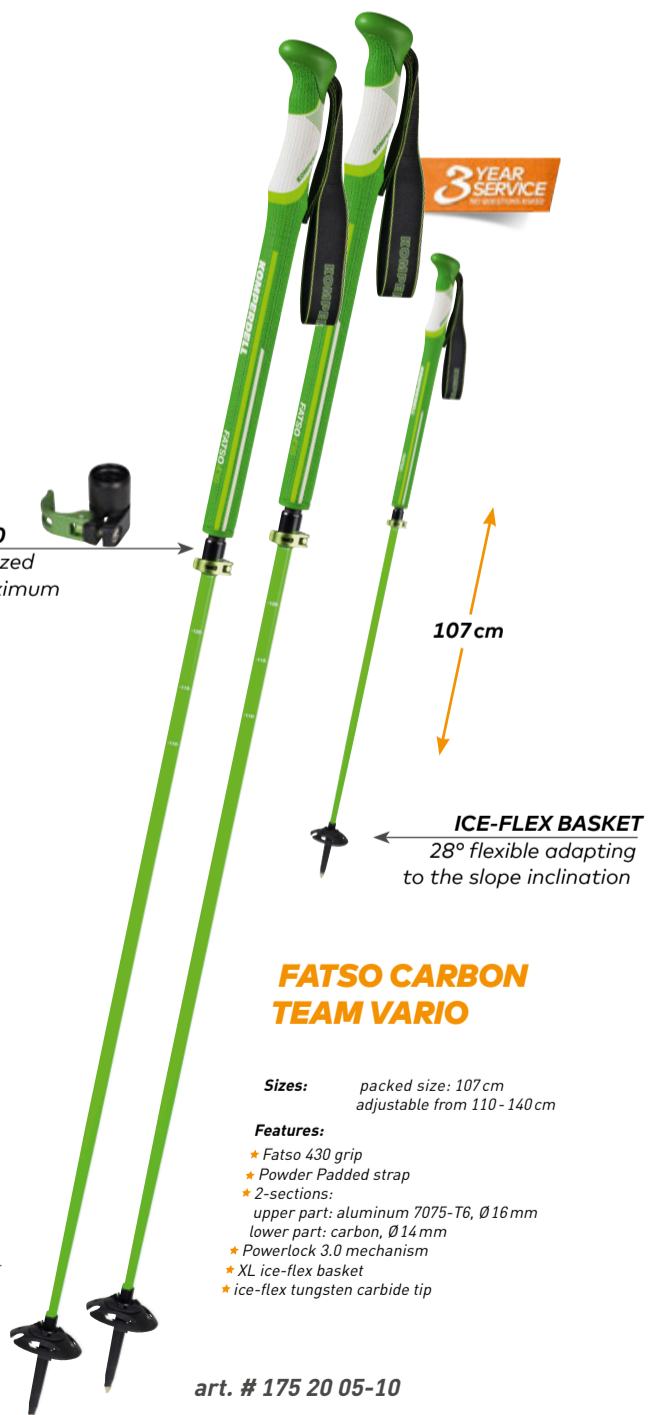

TOURING DESCENT

Poles designed to work great both on and off piste.



3 YEAR SERVICE

97 cm

POWERLOCK 3.0
highly rigid, anodized aluminum for maximum holding power!

DESCENT CARBON ROCKSLEEVE VARIO

Sizes: packed size: 97 cm
adjustable from 110 - 140 cm

Features:

- * Pistol 2K grip
- * Powder Padded strap
- * Rubber grip with THERMOZONE
- * 2-sections:
upper part: aluminum 7075-T6, Ø 18 mm
lower part: carbon rocksleeve, Ø 16 mm
- * ice-flex basket
- * ice-flex tungsten carbide tip
- * Powerlock 3.0 mechanism

■ art. # 184 23 74-10

DESCENT CARBON ROCKSLEEVE THERMO

Sizes: 105 - 135 cm
(in 5 cm steps)

Features:

- * Pistol 2K grip
- * Powder Padded strap
- * Rubber grip with THERMOZONE
- * carbon rocksleeve, Ø 16 mm
- * ice-flex basket
- * ice-flex tungsten carbide tip

■ art. # 148 23 29-10

DESCENT CARBON ROCKSLEEVE

Sizes: 105 - 135 cm
(in 5 cm steps)

Features:

- * Pistol 2K grip
- * Comfort Padded strap
- * carbon rocksleeve, Ø 16 mm
- * ice-flex basket
- * ice-flex tungsten carbide tip

■ art. # 148 23 32-10

TOURING DESCENT TI

Perfect performance
on and off piste.



POWERLOCK 3.0
highly rigid, anodized
aluminum for maximum
holding power!

3 YEAR SERVICE

97 cm

DESCENT TI VARIO

Sizes: packed size: 107 cm
adjustable from 110 - 140 cm

Features:

- ★ Pistol 2K grip
- ★ Comfort Padded strap
- ★ Rubber grip with THERMOZONE
- ★ 2-sections:
upper part: aluminum 7075-T6, Ø 18 mm
lower part: Titanal.HF, Ø 16 mm
- ★ ice-flex basket
- ★ ice-flex tungsten carbide tip
- ★ Powerlock 3.0 mechanism

■ art. # 184 23 75-12



DESCENT TI

Sizes: 105 - 135 cm
(in 5 cm steps)

Features:

- ★ Pistol 2K grip
- ★ Comfort Padded strap
- ★ Rubber grip with THERMOZONE
- ★ aluminum 7075-T6, Ø 18 mm
- ★ ice-flex basket
- ★ ice-flex tungsten carbide tip

■ art. # 134 23 05-12

FXP FOLDING POLE

The first and only self deploying folding pole!

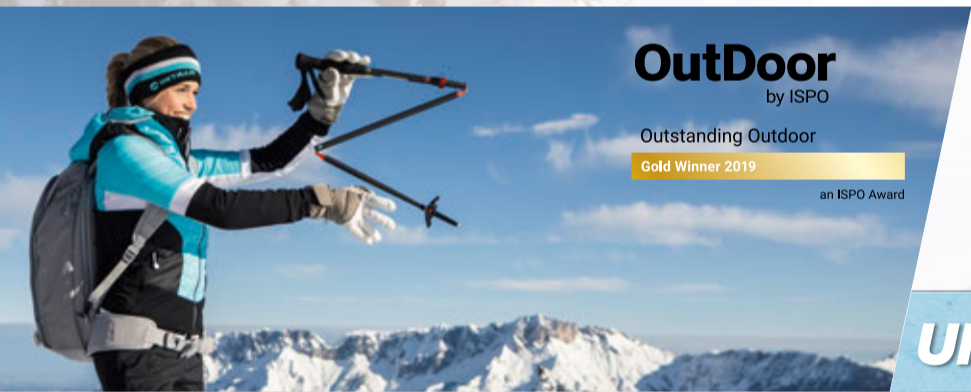

OutDoor
by ISPO

Outstanding Outdoor

Gold Winner 2019

an ISPO Award

UNFOLD

1

30% LIGHTER

Our newly developed FXP folding poles are up to 30% lighter. Due to the reduction of parts in the folding mechanism from 11 to 3 there is a significant difference in weight and handling.



RELEASE

2

THE FIRST FOLDING POLE FOR ALL SEASONS

The fixed mechanical connection of the parts prevents slacks between the pipe segments and thus no disturbing noises can occur. With the FXP poles there is no more force on the push button.



READY GO

3

THE FASTEST FOLDING MECHANISM

The new Komperdell. FXP pole deploys completely by itself and provides a secure and solid connection between the individual segments. The poles are suitable for hiking, trail running, ski touring or fly fishing - finally a pole that really works all year round!

TOURING FXP

When released, our new FXP Folding pole deploys completely by itself – pure genius.



AWARDED WITH

Outdoor

by ISPO
Outstanding Outdoor
Gold Winner 2019

an ISPO Award

3 YEAR SERVICE

3 YEAR SERVICE

43 cm

38 cm
5 cm smaller
packed size

CARBON FXP.4 EXPEDITION VARIO

Sizes: packed size: 43 cm
adjustable from 120 - 140 cm

Weight: 248g

Features:

- * expedition short grip
- * Comfort Padded strap
- * 4-sections:
- Carbon, Ø 18/16 mm
- * lower part: Titanal, HF Rocksleeve
- * Powerlock 3.0 mechanism
- * FXP folding mechanism
- * ice flex basket
- * ice flex tungsten/carbide tip

art. # 194 23 46-10

CARBON FXP.4 EXPEDITION VARIO COMPACT

Sizes: packed size: 38 cm
adjustable from 105 - 125 cm

Weight: 237g

Features:

- * expedition short grip
- * Comfort Padded strap
- * 4-sections:
- Carbon, Ø 18/16 mm
- * lower part: Titanal, HF Rocksleeve
- * Powerlock 3.0 mechanism
- * FXP folding mechanism
- * ice flex basket
- * ice flex tungsten/carbide tip

art. # 194 23 47-10



TOURING TITANAL.HF

Developed for backcountry skiers and splitboarders, who need a small packed size.



CARBON CXP PRO

Sizes: packed size: 65 cm
adjustable from 105 - 140 cm

- Features:**
- ★ TOURING 2-K FOAM 450 grip
 - ★ Comfort Padded strap
 - ★ 3-sections:
upper part: carbon, Ø 18 mm
middle part: carbon, Ø 16 mm
lower part: Titanal.HF, Ø 14 mm
 - ★ Powerlock 3.0 mechanism
 - ★ XL ice-flex basket
 - ★ vario tungsten/carbide flex tip

art. # 175 23 54-10

POWERLOCK 3.0
highly rigid, anodized
aluminum for maximum
holding power!



TITANAL EXP PRO

Sizes: packed size: 65 cm
adjustable from 105 - 140 cm

- Features:**
- ★ TOURING 2-K FOAM 450 grip
 - ★ Comfort Padded strap
 - ★ 3-sections:
Titanal .HF, Ø 18/16/14 mm
 - ★ Powerlock 3.0 mechanism
 - ★ XL ice-flex basket
 - ★ vario tungsten/carbide flex tip

art. # 174 23 55-10

AMAG
ROLLING

TOURING ULTRALIGHT

The C2
- our lightest touring pole -
only 193 grams



3 YEAR SERVICE

98 cm

POWERLOCK 3.0
highly rigid, anodized
aluminum for maximum
holding power!

CARBON C2 ULTRALIGHT

Sizes: packed size: 98 cm
adjustable from 110 - 140 cm

Features:

- * Touring Foam 280 grip
- * Comfort Padded strap
- * 2-sections:
upper part: carbon, Ø 16 mm
lower part: carbon, Ø 14 mm
- * Powerlock 3.0 mechanism
- * XL ice-flex basket
- * ice-flex tungsten/carbide tip

- art. # 175 23 52-10 orange
- art. # 175 23 53-10 berry



3 YEAR SERVICE

98 cm

ICE-FLEX BASKET
28° flexible adapting
to the slope inclination

CARBON CR ROCKSLEEVE

Sizes: packed size: 98 cm
adjustable from 110 - 140 cm

Features:

- * Touring Foam 280 grip
- * Comfort Padded strap
- * 2-sections:
upper part: aluminum 7075-T6, Ø 18 mm
lower part: carbon with rocksleeve, Ø 16 mm
- * Powerlock 3.0 mechanism
- * XL ice-flex basket
- * ice-flex tungsten/carbide tip

- art. # 184 23 80-02 blue



3 YEAR SERVICE

98 cm

CARBON C7 ASCENT

Sizes: packed size: 98 cm
adjustable from 110 - 140 cm

Features:

- * Touring FATS0 grip
- * Comfort Padded strap
- * 2-sections:
upper part: aluminum 7075-T6, Ø 16 mm
lower part: carbon, Ø 14 mm
- * Powerlock 3.0 mechanism
- * XL ice-flex basket
- * ice-flex tungsten/carbide tip

- art. # 184 23 78-02 green
- art. # 184 23 77-02 blue
- art. # 184 23 76-02 berry

TOURING TITANAL.HF

The iconic Contour Titanal stands for absolute reliability in the backcountry.



FREE TOURING TI

Sizes: packed size: 100 cm
adjustable from 105 - 135 cm

Features:

- * Touring Foam 280 grip
- * Comfort Padded strap
- * 2-sections:
upper part: aluminum 7075-T6, Ø 18 mm
lower part: Titanal, Ø 16 mm
- * Powerlock 3.0 mechanism
- * XL ice-flex basket
- * ice-flex tungsten/carbide tip

■ art. # 184 23 81-02



CONTOUR TITANAL II FOAM

Sizes: packed size: 85 cm
adjustable from 105 - 140 cm

Features:

- * TOURING 2-K FOAM 450 grip
- * Comfort Padded strap
- * 2-sections:
Titanal.HF, Ø 16/14 mm
- * Powerlock 3.0 mechanism
- * XL vario winter basket
- * vario tungsten/carbide flex tip

■ art. # 188 23 05-10



CONTOUR TITANAL II FOAM COMPACT

Sizes: packed size: 80 cm
adjustable from 105 - 130 cm

Features:

- * TOURING 2-K FOAM 450 grip
- * Comfort Padded strap
- * 2-sections:
Titanal.HF, Ø 16/14 mm
- * Powerlock 3.0 mechanism
- * XL vario winter basket
- * vario tungsten/carbide flex tip

■ art. # 188 23 06-10

TOURING ALUMINUM



THERMO ASCENT TI 3

Sizes: packed size: 72cm
adjustable from 115 - 150cm

- Features:**
- * EVA foam grip
 - * Thermogrip foam
 - * system strap wide
 - * 3-section:
 - aluminum 7075-T6, Ø 18/16/14mm
 - * Powerlock 3.0 mechanism
 - * vario winter basket
 - * vario tungsten/carbide flex tip

art. # 174 23 54-10



THERMO ASCENT TI 2

Sizes: packed size: 85cm
adjustable from 115 - 150cm

- Features:**
- * EVA foam grip
 - * Thermogrip foam
 - * system strap wide
 - * 2-section:
 - aluminum 7075-T6, Ø 18/16mm
 - * Powerlock 3.0 mechanism
 - * vario winter basket
 - * vario tungsten/carbide flex tip

art. # 184 23 84-10



POWDER TRAIL 2

Size: packed size: 85 cm
adjustable from 105 - 145 cm

- Features:**
- * EVA foam grip
 - * system strap wide
 - * 2-sections:
 - aluminum 7075-T6, Ø 18/16mm
 - * Powerlock 3.0 mechanism
 - * vario winter basket
 - * vario tungsten/carbide flex tip

art. # 184 23 83-10

TOURING STILETTO

Length adjustment directly on the grip – exclusive and only from Komperdell.



SUPERIOR BALANCE

Better balance and support in rough terrain, on high steps or when traversing a creek.



UPHILL BOOST

By having the correct pole-length at all times you achieve better transmission of power.



RELIEVES STRAIN ON YOUR KNEES

The strain on your knees is reduced because you always have your poles at the correct length.

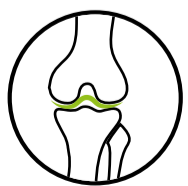

STILETTO EXPEDITION

Sizes: packed size: 62 cm
130 cm, adjustable from 105 - 130 cm
140 cm, adjustable from 115 - 140 cm

- Features:
- * Stiletto 400 grip
 - * Ergo strap
 - * top part: Titanal.HF
 - * lower part: Carbon
 - * ice-flex basket
 - * ice-flex tungsten/carbide tip

art. # 184 20 02-02



STILETTO TOUR

Sizes: 130 cm, adjustable from 105 - 130 cm
140 cm, adjustable from 115 - 140 cm

- Features:
- * Stiletto 400 grip
 - * Ergo strap
 - * top part: Titanal.HF
 - * lower part: Carbon
 - * ice-flex basket
 - * ice-flex tungsten/carbide tip

art. # 184 20 03-02



ADJUSTMENT MECHANISM IN THE GRIP – FAST, INTUITIVE & SIMPLE
adjust the length anytime, adapt to any situation and slope incline

AWARDED WITH





STORMHOOD

- Sizes:** Junior/Adult
Features:
- * BC-Flex with rapid-dry function
 - * 4-way stretch – extra elastic
 - * perfect to be worn under helmet

art. # 6210-02 Adult
 art. # 6211-02 Junior



ARCTIC STORMHOOD

- Sizes:** unisex
Features:
- * BC-Flex with rapid-dry function
 - * fleece/spandex material
 - * warming hood for extra cold temperatures

art. # 6216-02



ARCTIC SCARF

- Sizes:** unisex
Features:
- * fleece/elasthan material
 - * multifunctional headgear
 - * to be used as scarf, cap or headband

art. # 6209-02



FLEECE MASK

- Sizes:** Junior/Adult
Features:
- * fleece material
 - * fully adjustable with velcro fastener

art. # 6212-02 Adult
 art. # 6213-02 Junior



NEOPRENE MASK

- Sizes:** Junior/Adult
Features:
- * neoprene material
 - * fully adjustable with velcro fastener

art. # 694-02 Adult
 art. # 603-02 Junior



KNITTED NOSTALGIC CAP

- Sizes:** unisex
Features:
- * 100% soft acrylic
 - * retro look – still a sales hit

□ art. # 602-1 weiß/rot
 ■ art. # 602-2 schwarz/rot

MERINO WOOL →



ALPINE MERINO

- Sizes:** XS - XXL
Features:
- * seamless: wind- & waterproof
 - * breathable 4-layer material concept
 - * non slip & abrasion-resistant palm
 - * merino wool mix inside lining for optimal heat insulation

art. # 401-02

MERINO WOOL →



FREERIDE LIGHT

- Sizes:** XS - XXL
Features:
- * seamless: wind- & waterproof
 - * breathable 4-layer material concept
 - * palm with abrasion-resistant kevlar-material
 - * merino wool mix inside lining for optimal heat insulation

art. # 447-02

BC FLEX
 outside lining →



TOURING BC FLEX

- Sizes:** XS - XXL
Features:
- * seamless: wind- & waterproof
 - * 3-layer material concept
 - * odour-neutralizing & breathable
 - * humidity-absorbing
 - * palm with non-slip material
 - * comfortable soft brushed BC-Flex inside-lining
 - * extra light & thin material

art. # 410-02

TERRY CLOTH
 lining in- & outside →



TOURING FROTTEE

- Sizes:** XS - XL
Features:
- * seamless: wind- & waterproof
 - * 3-layer material concept
 - * breathable & humidity-absorbing
 - * palm with non-slip silicone print
 - * extra warm terry cloth lining for cold winter tours
 - * middle- and ring finger made of soft-shell material

art. # 411-03



RACING GLOVE

- Sizes:** XS - XL
Features:
- * genuine leather
 - * special heat insulation
 - * knuckles protection out of carbon
 - * shock absorbing foam on fingers, thumb and back of the hand

art. # 6501-02



RACING LOBSTER

- Sizes:** XS - XL
Features:
- * genuine leather
 - * special heat insulation
 - * knuckles protection out of carbon
 - * shock absorbing foam on fingers, thumb and back of the hand

art. # 6502-02

OVERCOAT →



THERMO MITTENS

- Sizes:** S & L
Features:
- * neoprene mitten to wear over a 5-finger glove
 - * optimal heat insulation in case of low temperatures
 - * multifunctional usage

art. # 405-02



LEATHER GLOVES

- Sizes:** S [6,5]
 M [7,5]
 L [9]
 XL [10]
Features:
- * genuine leather
 - * extra warm

art. # 441-02

WINTER PROTECTION

PIONEER - TRENDSETTER - MULTIPLE AWARD WINNER



WASHABLE

our protectors can be washed without any problems

HIGHEST DURABILITY

the innovative combination of various foam layers makes our protectors extra strong and durable against external forces

ABSORBS MORE THAN 93% OF THE IMPACT ENERGY

The impact forces are absorbed by a combination of various different layers

THERMO FIT - ADAPTS THROUGH BODY TEMPERATURE

– when worn, the dual density foam adapts to the body contours

MAXIMUM BREATHABILITY

provided by smart materials and a breathable construction

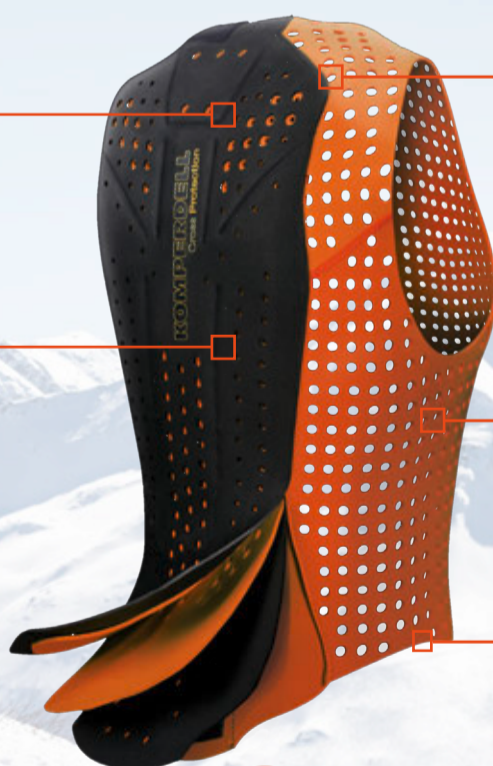

1

PIONEER

For more than 20 years we have been developing protectors for the world's leading motorcycle brands. Through the close cooperation with our customers we have gained invaluable know-how on how to best protect our customers. Like no other brand we have influenced the market for modern protection but we always stayed true to our mission to develop and improve our protectors to make them safer and easier to wear.

2

TRENDSETTER

We are the only brand to develop and manufacture not only the garment but the protector itself. This unique know-how allows us to develop the protector and garment as one cohesive unit. This makes our protectors much better to wear without sacrificing their protective properties. Today we are able to integrate our protectors into the lightest garments and still provide the best protection on the market.

3

AWARD WINNER

No other brand has won as many awards in so many different fields as we did. More than 30 awards for our motorcycle, winter sports, bike and equestrian protectors give proof to our claim to provide the best possible protection on the market.

PROTECTION ATHLETIC MEN

Our safest protectors with additional chest protection.



BALLISTIC VEST MEN

Sizes: XXS - XXL

Features:

- ★ multilayer Cross 6.0 back-protector, made of adaptive dual-density foam, EN-approved 1621-2
- ★ light and flexible
- ★ highest safety values - 360° all around protection
- ★ for ultimate mobility
- ★ front zipper

art. # 6273-206



REVERSIBLE VEST
can be worn on
both sides



ADDITIONAL
PROTECTORS
safeguard ribs
and organs



PRO VEST MEN

Sizes: XS - XXL

Features:

- ★ multilayer Cross 6.0 back protector made of adaptive dual-density foam, EN-approved 1621-2
- ★ side protection of ribs and organs
- ★ slim kidney-belt for perfect fit, adjustable with velcro and plush
- ★ concealed chest-pocket with zip

art. # 6320-202

PROTECTION ATHLETIC MEN



AIR VEST ORANGE

Sizes: XXS - XXL

Features:

- * extra light protector vest with optimized fit
- * multilayer Cross 6.0 Lite back protector made of adaptive dual-density foam, EN-approved 1621-2
- * concealed chest pocket with zip
- * slim kidney belt for perfect fit, adjustable with velcro and plush

art. # 6318-202



AIR VEST BLUE

Sizes: XXS - XXL

Features:

- * extra light protector vest with optimized fit
- * multilayer Cross 6.0 Lite back protector made of adaptive dual-density foam, EN-approved 1621-2
- * concealed chest pocket with zip
- * slim kidney belt for perfect fit, adjustable with velcro and plush

art. # 6318-207

PROTECTION ATHLETIC WOMEN

The Ballistic Vest - our award winning full body protector.



BALLISTIC VEST WOMEN

Sizes: XXS - XL

Features:

- ★ multilayer Cross 6.0 back protector made of adaptive dual-density foam, EN-approved 1621-2
- ★ improved ergonomometry
- ★ perfect fit & ultimate mobility

art. # 6277-209



ADDITIONAL
PROTECTORS
safeguard ribs
and organs



PRO VEST WOMEN

Sizes: XXS - XL

Features:

- ★ multilayer Cross 6.0 back protector made of adaptive dual-density foam, EN-approved 1621-2
- ★ side protection of ribs and organs
- ★ slim kidney-belt for perfect fit, adjustable with velcro and plush
- ★ concealed chest-pocket with zip

art. # 6358-207

PROTECTION ATHLETIC WOMEN



AIR VEST WOMEN

Sizes: XXS - XL

Features:

- ★ multilayer Cross 6.0 Lite back protector made of adaptive dual-density foam, EN-approved 1621-2
- ★ extra light protector vest
- ★ optimized silhouette

art. # 6319-209

PRO SHORT

Sizes: unisex, XXS - XXL

Features:

- ★ comfortable foam material for optimal protection of coccyx, thighs and hips
- ★ sporty look

art. # 6355-212

PROTECTION KIDS CORNER

The Ballistic Vest - 360° full body protection because only the best is good enough for your kids.



ULTIMATE
FREEDOM OF MOVEMENT
for more fun in the snow

ADDITIONAL
RIB PROTECTORS
perfectly
protected

360°
PROTECTION

BALLISTIC VEST JUNIOR

Sizes: 116 - 152

Features:

- * multilayer Cross 6.0 Junior back protector made of adaptive dual-density foam, EN-approved 1621-2
- * 360° all around protection - top protection values
- * light and flexible



ISPO AWARD
WINNER
2016/2017

PRO SHORT JUNIOR

Sizes: 116 - 152

Features:

- * comfortable foam material for optimal protection of hips
- * slip-proof rubber band at waist and legs

■ art. # 6321-202

■ art. # 6321-209

■ art. # 6321-208

art. # 6359-212



BACK PROTECTION
multilayer Cross 6.0 protector
for optimal protection

FULL PROTECTOR SLALOM SHIRT LONG

Sizes: Adult: XS - XL
Junior: 116 - 152

Features:
 * perfect breathability, comfortable to wear
 * multilayer Cross 6.0 back-protector, made of adaptive dual-density foam, EN-approved 1621-2
 * perfect protection of back, shoulders, shoulderblades & arms

art. # 6301-208 Adult
art. # 6302-208 Junior



PROTECTOR SLALOM SHIRT

Sizes: Adult: XS - XL
Junior: 116 - 152

Features:
 * perfect breathability, comfortable to wear
 * body-shape cut
 * multilayer protectors made of dual-density foam
 * perfect protection of shoulders, shoulderblades and arms
 * specially shaped back for perfect combination with the FIS approved FlexPack

art. # 6283-02 Adult
art. # 6284-02 Junior



PRO SHORT

Sizes: unisex, XXS - XXL

Features:
 * comfortable foam material for optimal protection of coccyx, thighs and hips
 * sporty look

art. # 6355-212



ELBOW PROTECTOR

Sizes: S/M, L/XL

Features:
 * EN-approved

art. # 6361-02



KNEE PROTECTOR

Sizes: S/M, L/XL

Features:
 * EN-approved

art. # 6360-02



FLEX PACK

Sizes: Adult: XXS - XL
Junior: 128 - 140 - 152

Features:
 * multilayer Cross 6.0 back-protector made of adaptive dual-density foam, EN-approved 1621-2
 * conforms to FIS regulations
 * anatomic shaped back part
 * new preshaped strap system for best fit - shoulder it like a backpack
 * protector insert visible - part of the design concept
 * ultimate freedom of movement
 * slim kidney belt for perfect fit, adjustable with velcro and plush

art. # 6362-213 Adult
art. # 6363-213 Junior

CASUAL PROTECTION

A completely new way of combining protection and comfort.



EVEN BETTER CONCEALED

the new Cross Flex Protector provides comfort and safety without any compromises

CLEVER

integrated into a casual hoody – it's so easy to wear that you hardly feel it

1

CONCEPT

Through many and long conversations with our customers we learned that many customers do not want to wear the protectors as a separate piece but would prefer to have the protective technology smartly integrated into an existing layer. The protector becomes an added benefit to a layer they already wear.

2

FINE TUNING

As the only brand we design, develop and manufacture both our protective technology and our apparel. This unique know-how gives us the opportunity to design both the protector and the garment as one single integrated piece. This makes the protector part of the garment and no longer a separate piece.

3

THE PERFECT PROTECTOR

Our mission has always been to provide the best protection possible. This is our obligation to our customers and something we are not willing to compromise on. Although our new casual protectors with the new Cross Flex System are so light that you almost don't feel them, they still provide the same quality of protection as our athletic protectors.

NEW! CROSS FLEX PROTECTOR

30% lighter and extremely flexible

ABSORBS MORE THAN 93% OF THE IMPACT ENERGY

The impact forces are absorbed by a combination of various different layers.

THERMO FIT - ADAPTS THROUGH BODY TEMPERATURE

– when worn, the dual density foam adapts to the body contours



PROTECTION CASUAL

Protection that's great to wear in a cool new optic.



HOODY
made of super-soft fleece,
snug & warm



CROSS FLEX PROTECTOR
the safest protection –
EN 1621-2



**KANGAROO
POCKETS**



FULL ZIP HOODY SHIRT MEN

Sizes: XS - XXL

Features

- * multilayer Cross FLEX back-protector, made of adaptive dual-density foam, EN-approved 1621-2
- * made of comfortably fitting fleece
- * 4-way stretch- material
- * hood with draw-string
- * Integrated kidney-belt adjustable with velcro fastener
- * front zip

art. # 6353-207

FULL ZIP SWEATER MEN

Sizes: XS - XXL

Features

- * multilayer Cross FLEX back-protector, made of adaptive dual-density foam, EN-approved 1621-2
- * made of comfortably fitting fleece
- * 4-way stretch- material
- * Integrated kidney-belt adjustable with velcro fastener
- * front zip

art. # 6354-207

art. # 6354-202

PROTECTION CASUAL

Our new protection is incredibly comfortable without compromising its protective properties.



4-WAY STRETCH LIGHT SHELL MATERIAL
for comfort



CONCEALED SIDE BREAST POCKETS
with zip



CONCEALED SIDE-POCKETS
with zip

REMOVEABLE HOOD
fully customizable with draw-string and rubber cord



INTEGRATED KIDNEY-BELT
adjustable with velcro-fastener



BEST COLD & WIND PROTECTION
due to thermo-insulating, extra light technical materials



THERMOVEST MEN

Sizes: S - XXL

Features:

- * multilayer Cross 6.0 back-protector, made of adaptive dual-density foam, EN-approved 1621-2
- * innovative material-mix: extra-light light shell material combined with smart breathable thermo-padding
- * removeable hood stormproof
- * concealed chest pocket with zip & 2 concealed side-pockets

art. # 6351-207



PROTECTION CASUAL

Style and protection in perfection.



HOODY
made of super-soft fleece,
snug & warm



CROSS FLEX PROTECTOR
the safest protection –
EN 1621-2



KANGAROO POCKETS

FULL ZIP HOODY SHIRT WOMEN

Sizes: XXS - XL

Features

- * multilayer Cross FLEX back-protector, made of adaptive dual-density foam, EN-approved 1621-2
- * made of comfortably fitting fleece
- * 4-way stretch- material
- * hood with draw-string
- * integrated kidney-belt adjustable with velcro fastener
- * front zip

art. # 6356-240



FULL ZIP SWEATER WOMEN

Sizes: XXS - XL

Features

- * multilayer Cross FLEX back-protector, made of adaptive dual-density foam, EN-approved 1621-2
- * made of comfortably fitting fleece
- * 4-way stretch- material
- * Integrated kidney-belt adjustable with velcro fastener
- * front zip

art. # 6357-240

art. # 6357-209

PROTECTION CASUAL

Exceptional comfort combined with the best protection on the market.



4-WAY STRETCH LIGHT SHELL MATERIAL
for comfort



CONCEALED SIDE BREAST POCKETS
with zip



CONCEALED SIDE-POCKETS
with zip

REMOVEABLE HOOD
fully customizable with draw-string and rubber cord



INTEGRATED KIDNEY-BELT
adjustable with velcro-fastener



BEST COLD & WIND PROTECTION
due to thermo-insulating, extra light technical materials



THERMOVEST WOMEN

Sizes: XS - XL

Features:

- ★ multilayer Cross 6.0 back-protector, made of adaptive dual-density foam, EN-approved 1621-2
- ★ innovative material-mix: extra-light light shell material combined with smart breathable thermo-padding
- ★ removeable hood stormproof
- ★ concealed chest pocket with zip & 2 concealed side-pockets

art. # 6352-209



BIKE PROTECTION

A new style of protection for urban bikers and mountainbikers.



1

THE BEST PROTECTOR

20 years of experience as market leader for motorcycle, wintersports and equestrian protectors give us the know-how and experience to develop a truly unique concept for a bike protector. We are the only brand to develop and manufacture our own protector technology. This gives us the unique opportunity to develop the pack and protector as one cohesive unit.



2

WELL THOUGHT SYSTEM

Whereas protectors are standard in motorcycle and skiing, the concept is relatively new to the bike market although the need for protection is probably greater than in one of the previously mentioned fields. We completely rethought the conventional concept of a bike protector. Instead of integrating a protector plate into an existing backpack, we concentrated all our energy on developing an ergonomically perfect protector and then combine it with a smartly designed pack.



3

UNIQUE PRODUCT

Our Komperdell Protector Pack guarantees best comfort and maximum safety. The protector is soft and flexible because of the dual density foam that adapts to the body contours when worn. We offer safety and protection and a variety of extras e.g. wasser reservoir, storm jacket or raincover. Our protectors are multi impact compliant and washable.

PROTECTION URBAN

Protector and urban pack in one - properly protected in an urban environment.



- Climate Design
- Top Impact Value
- Ergonomic Shape

STORM JACKET
integrated,
waterproof



URBAN PROTECTORPACK

Sizes: unisex
black; XS - 3XL

- Features:**
- * multilayer Cross 7.1 FB back protector made of adaptive dual-density foam, EN-approved 1621-2
 - * back protection
 - * waterproof storm jacket included
 - * lightweight and flexible
 - * highest safety values
 - * slim kidney belt for perfect fit

art. # 6346-02

Optional:

- * BATTERPACK
padded pack for spare battery
- * NOTEBOOKCASE S - M - L
padded pack for Pads/Notebooks

Inclusive:

- * STORM JACKET XS - 3XL
waterproof and breathable jacket

art. # 6348-02

art. # 6349-02

art. # 6350-02

art. # 6350-18

PROTECTION MOUNTAINBIKE

Ergonomically perfect protector for mountainbikers. A fantastic fit and enough storage for all eventualities.



Climate Design

Top Impact Value

Ergonomic Shape

WATER RESERVOIR integrated 2L

MTB-PRO PROTECTORPACK

Sizes: unisex
black/green; S - M - L
black/blue; M - L
black/malbec; S - M

- Features:**
- * multilayer Cross 7.1 FB back protector made of adaptive dual-density foam, EN-approved 1621-2
 - * Raincover included
 - * lightweight and flexible
 - * highest safety values
 - * slim kidney belt for perfect fit
 - * washable

■ art. # 6338-213

■ art. # 6339-04

■ art. # 6340-230

Optional:

* BATTERPACK
padded pack for spare battery

* NOTEBOOKCASE S - M - L
padded pack for Pads/Notebooks

* STORM JACKET XS - 3XL
waterproof and breathable jacket

Inclusive:

- * WATER RESERVOIR 2L
- * RAINCOVER

art. # 63 48-02

art. # 63 49-02

■ art. # 6350-02

■ art. # 6350-18

PROTECTION RENTAL

EN-approved 1621-2, because safety is the top priority when it comes to rental protection.



Climate Design

Top Impact Value

Ergonomic Shape



MTB ECO / RENTAL PROTECTORPACK

Sizes: unisex
black/green; S - M - L

Features:

- * multilayer Cross 7.1 FB back protector made of adaptive dual-density foam, EN-approved 1621-2
- * Raincover included
- * lightweight and flexible
- * highest safety values
- * slim kidney belt for perfect fit
- * washable
- * individual logo possible

art. # 6347-02

Optional:

- * BATTERPACK
padded pack for spare battery

art. # 63 48-02



We are Komperdell! Passion and honest quality made in Austria.



WE STILL MANUFACTURE IN AUSTRIA

We are proud that we still manufacture in Austria. Each of our products is created from the initial idea to the product ready for series production in our main factory in Austria/Mondsee. For us, sustainability means a conscious, long-term approach to our environment - to nature, employees, business partners and above all to our customers.

INNOVATION

The urge to constantly question ourselves how we can become even better, the courage to take unconventional paths and the passion for our customers to offer the best product and the best service are what sets us apart from others. The best athletes in the world trust in our products and we want to pass on exactly this service and quality to our customers.

HONESTY AND SERVICE

From the initial idea to the finished series each of our products is 100% manufactured in our headquarters in Austria. The satisfaction of our customers is our constant motivation. We do not want to only produce top products, but also offer the best service. Our free 3-year repair service shows this. Everything we do, we do with integrity, credibility and honesty. In every Komperdell product you will feel our passion for highest quality and the heart and soul of our team.

TREKKING FXP

The foldable pole, which completely deploys by itself.
Unique and only from Komperdell.



3 YEAR SERVICE
BY KOMPERDELL

**CARBON FXP.4
TRAIL ULTRALIGHT
VARIO**

Sizes: packed size: 41 cm
adjustable from 115 - 135 cm

Weight: 206g

Features:

- * expedition short grip
- * Padded strap
- * 4-sections:
Carbon, Ø 18/16 mm
- * Powerlock 3.0 mechanism
- * FXP folding mechanism
- * FXP-UL VARIO basket
- * tungsten/carbide flex tip

OutDoor
by ISPO
Outstanding Outdoor
Gold Winner 2019

art. # 194 23 38-10

3 YEAR SERVICE
BY KOMPERDELL

**CARBON FXP.4
TRAIL ULTRALIGHT
VARIO COMPACT**

Sizes: packed size: 38 cm
adjustable from 105 - 125 cm

Weight: 199g

Features:

- * expedition short grip
- * Padded strap
- * 4-sections:
Carbon, Ø 18/16 mm
- * Powerlock 3.0 mechanism
- * FXP folding mechanism
- * FXP-UL VARIO basket
- * tungsten/carbide flex tip

OutDoor
by ISPO
Outstanding Outdoor
Gold Winner 2019

art. # 194 23 39-10

3 YEAR SERVICE
BY KOMPERDELL

**CARBON FXP.4
SUMMIT VARIO**

Sizes: packed size: 41 cm
adjustable from 115 - 135 cm

Weight: 217g

Features:

- * expedition short grip
- * Padded strap
- * 4-sections:
Carbon, Ø 18/16 mm
- * Powerlock 3.0 mechanism
- * FXP folding mechanism
- * FXP-UL VARIO basket
- * tungsten/carbide flex tip

OutDoor
by ISPO
Outstanding Outdoor
Gold Winner 2019

art. # 194 23 42-10

3 YEAR SERVICE
BY KOMPERDELL

**CARBON FXP.4
SUMMIT VARIO
COMPACT**

Sizes: packed size: 38 cm
adjustable from 105 - 125 cm

Weight: 210g

Features:

- * expedition short grip
- * Padded strap
- * 4-sections:
Carbon, Ø 18/16 mm
- * Powerlock 3.0 mechanism
- * FXP folding mechanism
- * FXP-UL VARIO basket
- * tungsten/carbide flex tip

OutDoor
by ISPO
Outstanding Outdoor
Gold Winner 2019

art. # 194 23 43-10

TREKKING TRAILSTICKS



POWERLOCK 3.0
highly rigid, anodized aluminum for maximum holding power!

HIGH-END CARBON
for extremely low total weight

**TRAILSTICK CARBON
C4 VARIO ROCKSLEEVE**

3 YEAR SERVICE

38 cm

Sizes: packed size: 38 cm
adjustable from 115 - 135 cm

Weight: 256g

Features:

- * expedition short grip
- * Padded trekking strap
- * 4-sections, 2-times foldable: 100% Carbon
- * Trailstick system
- * Powerlock 3.0 mechanism
- * Hexagon basket
- * Trailstick tungsten/carbide tip

art. # 194 23 41-10

TRAILSTICK SYSTEM
An integrated tensioning construction, high quality aluminum elements and a steel rope covered with an abrasion resistant coating guarantee a solid pole.

**TRAILSTICK CARBON
C4 VARIO ROCKSLEEVE
COMPACT**

3 YEAR SERVICE

35 cm
3 cm smaller packed size

Sizes: packed size: 35 cm
adjustable from 105 - 125 cm

Weight: 251g

Features:

- * expedition short grip
- * Padded trekking strap
- * 4-sections, 2-times foldable: 100% Carbon
- * Trailstick system
- * Powerlock 3.0 mechanism
- * Hexagon basket
- * Trailstick tungsten/carbide tip

art. # 194 23 40-10



Ralf Dujsmovits

RALF DUJMOVITS
18x8000m

SERIES C3 CARBON

The lightest poles on the market,
you will feel with every step you take.

LONG GRIP ZONE →

3 YEAR SERVICE

POWERLOCK 3.0
67 cm highly rigid, anodized aluminum for max. holding power!

C3 CARBON PRO

Sizes: packed size: 67 cm
adjustable from 105 - 140 cm

Weight: 221 g

Features:

- * foam 280 grip
- * Padded trekking strap
- * long grip zone
- * 3-sections: top part: carbon, Ø 18 mm middle part: carbon, Ø 16 mm lower part: Titanal .HF, Ø 14 mm
- * Powerlock 3.0 mechanism
- * MINI-UL VARIO basket
- * tungsten/carbide flex tip

art. # 175 23 44-10

3 YEAR SERVICE

57 cm
10cm smaller packed size

C3 CARBON PRO COMPACT

Sizes: packed size: 57 cm
adjustable from 90 - 120 cm

Weight: 201 g

Features:

- * foam 280 grip
- * Padded trekking strap
- * long grip zone
- * 3-sections: top part: carbon, Ø 18 mm middle part: carbon, Ø 16 mm lower part: Titanal .HF, Ø 14 mm
- * Powerlock 3.0 mechanism
- * MINI-UL VARIO basket
- * tungsten/carbide flex tip

art. # 175 23 45-10

3 YEAR SERVICE

67 cm

C3 CARBON

Sizes: packed size: 67 cm
adjustable from 105 - 140 cm

Weight: 215 g

Features:

- * expedition short grip
- * Padded trekking strap
- * 3-sections: top part: carbon, Ø 18 mm middle part: carbon, Ø 16 mm lower part: Titanal .HF, Ø 14 mm
- * Powerlock 3.0 mechanism
- * MINI-UL VARIO basket
- * tungsten/carbide flex tip

art. # 175 23 47-10

3 YEAR SERVICE

CARBON
specially adapted & light weight tube. The pole weights unbelievable 199 g

57 cm
10cm smaller packed size

C3 CARBON COMPACT

Sizes: packed size: 57 cm
adjustable from 90 - 120 cm

Weight: 199 g

Features:

- * expedition short grip
- * Padded trekking strap
- * 3-sections: top part: carbon, Ø 18 mm middle part: carbon, Ø 16 mm lower part: Titanal .HF, Ø 14 mm
- * Powerlock 3.0 mechanism
- * MINI-UL VARIO basket
- * tungsten/carbide flex tip

art. # 175 23 48-10

TREKKING TITANAL.HF

Our Powerlock 3.0 is our strongest lock on the market – perfect for summer and winter.



LONG GRIP ZONE →

3 YEAR SERVICE

65 cm

**EXPLORER CONTOUR
POWERLOCK**

Sizes: packed size: 65 cm
adjustable from 105 - 140 cm

Weight: 239 g

Features:

- * foam 280 grip
- * Padded trekking strap
- * Titanal .HF, 3-sections Ø 18/16/14 mm
- * Powerlock 3.0 mechanism
- * MINI-UL VARIO basket
- * tungsten/carbide flex tip

TIPPREIS 100 Pre-Shop

art. # 174 23 12-10

3 YEAR SERVICE

57 cm
8cm smaller packed size

**EXPLORER COMPACT
POWERLOCK**

Sizes: packed size: 57 cm
adjustable from 90 - 120 cm

Weight: 220 g

Features:

- * foam 280 grip
- * Padded trekking strap
- * Titanal .HF, 3-sections Ø 18/16/14 mm
- * Powerlock 3.0 mechanism
- * MINI-UL VARIO basket
- * tungsten/carbide flex tip

TIPPREIS 100 Pre-Shop

art. # 174 23 13-10

3 YEAR SERVICE

68 cm
POWERLOCK 3.0 highly rigid, anodized aluminum for max. holding power!

**SHOCKMASTER
CORK POWERLOCK**

Sizes: packed size: 68 cm
adjustable from 105 - 140 cm

Weight: 289 g

Features:

- * Tour 170 cork 1K grip
- * Padded trekking strap
- * Titanal .HF, 3-sections Ø 18/16/14 mm
- * Powerlock 3.0 mechanism
- * MINI-UL VARIO basket
- * Shocktip

art. # 174 23 22-10

← **ANTISHOCK TIP** high-quality steel spring absorbs vibrations →

3 YEAR SERVICE

63 cm
5cm smaller packed size

**SHOCKMASTER CORK
POWERLOCK COMPACT**

Sizes: packed size: 63 cm
adjustable from 90 - 120 cm

Weight: 271 g

Features:

- * Tour 170 cork 1K grip
- * Padded trekking strap
- * Titanal .HF, 3-sections Ø 18/16/14 mm
- * Powerlock 3.0 mechanism
- * MINI-UL VARIO basket
- * Shocktip

art. # 174 23 23-10

TREKKING ALUMINUM

3-YEAR FREE REPAIR SERVICE

only by KOMPERDELL!

We repair our poles free of charge – no receipt necessary and no questions asked.



CORK GRIP
comfortable grip feeling

3 YEAR SERVICE

3 YEAR SERVICE

3 YEAR SERVICE

3 YEAR SERVICE

64 cm

57 cm
7cm smaller
packed size

64 cm

57 cm
7cm smaller
packed size

RIDGEHIKER CORK POWERLOCK

Sizes: packed size: 64 cm
adjustable from 105 - 140 cm

Weight: 268 g

Features:

- * Tour 170 cork 1K grip
- * Padded trekking strap
- * Aluminum 7075-T6, 3-sections Ø 18/16/14 mm
- * Powerlock 3.0 mechanism
- * MINI-UL VARIO basket
- * tungsten/carbide flex tip

art. # 174 23 24-10

RIDGEHIKER CORK POWERLOCK COMPACT

Sizes: packed size: 57 cm
adjustable from 90 - 120 cm

Weight: 250 g

Features:

- * Tour 170 cork 1K grip
- * Padded trekking strap
- * Aluminum 7075-T6, 3-sections Ø 18/16/14 mm
- * Powerlock 3.0 mechanism
- * MINI-UL VARIO basket
- * tungsten/carbide flex tip

art. # 174 23 25-10

HIKEMASTER POWERLOCK

Sizes: packed size: 64 cm
adjustable from 105 - 140 cm

Weight: 261 g

Features:

- * Trek 170 grip
- * Padded trekking strap
- * Aluminum 7075-T6, 3-sections Ø 18/16/14 mm
- * Powerlock 3.0 mechanism
- * MINI-UL VARIO basket
- * tungsten/carbide flex tip

BEST IN TEST
issue december 2018

art. # 174 23 20-02

HIKEMASTER POWERLOCK COMPACT

Sizes: packed size: 57 cm
adjustable from 90 - 120 cm

Weight: 243 g

Features:

- * Trek 170 grip
- * Padded trekking strap
- * Aluminum 7075-T6, 3-sections Ø 18/16/14 mm
- * Powerlock 3.0 mechanism
- * MINI-UL VARIO basket
- * tungsten/carbide flex tip

BEST IN TEST
issue december 2018

art. # 174 23 21-02

TREKKING ALUMINUM



TREKKING JUNIOR

A trekking pole for kids with an easy-to-use adjusting system - the pole that grows with your kid.



3 YEAR SERVICE

74 cm

POWERLOCK 3.0
highly rigid, anodized aluminum for max. holding power!

PEAK HUNTER JUNIOR POWERLOCK

Size: packed size: 74 cm
adjustable from 90 - 125 cm

Weight: 218 g

Features:

- * Tour 170 PE 1K grip
- * system strap
- * aluminum 7075-T6, 2-sections Ø 16/14 mm
- * Powerlock 3.0 mechanism
- * MINI-UL VARIO basket
- * flex steel tip

art. # 164 23 10-10

3 YEAR SERVICE

65 cm

TWISTLOCK
made with glass fiber reinforced plastics

TRAILBLAZER KIDS GREEN

Size: packed size: 65 cm
adjustable from 80 - 105 cm

Weight: 172 g

Features:

- * race grip junior
- * standard strap
- * upper part: aluminum 7075-T6, Ø 16 mm
- * lower part: aluminum 5083, Ø 14 mm
- * Twist Lock mechanism
- * MINI-UL VARIO basket
- * steel tip

art. # 164 23 11-10

3 YEAR SERVICE

65 cm

TRAILBLAZER KIDS PINK

Size: packed size: 65 cm
adjustable from 80 - 105 cm

Weight: 172 g

Features:

- * race grip junior
- * standard strap
- * upper part: aluminum 7075-T6, Ø 16 mm
- * lower part: aluminum 5083, Ø 14 mm
- * Twist Lock mechanism
- * MINI-UL VARIO basket
- * steel tip

art. # 164 23 12-10

WALKING ALUMINUM



3 YEAR SERVICE

61 cm

WALKER POWERLOCK

Sizes: packed size: 61 cm adjustable from 85 - 100 cm

Weight: 237 g

Features:

- * Walker comfort cork grip
- * Padded Walker strap
- * Aluminum 7075-T6, 2-sections Ø 16/14 mm
- * Powerlock 3.0 mechanism
- * MINI-UL VARIO basket
- * tungsten/carbide flex tip

art. # 186 23 02-10



3 YEAR SERVICE

46 cm
15cm shorter packed size

WALKER POWERLOCK COMPACT

Sizes: packed size: 46 cm adjustable from 75 - 100 cm



Weight: 259 g

Features:

- * Walker comfort cork grip
- * Padded Walker strap
- * Aluminum 7075-T6, 3-sections Ø 18/16/14 mm
- * Powerlock 3.0 mechanism
- * MINI-UL VARIO basket
- * tungsten/carbide flex tip

art. # 176 23 74-10

CAMERA MOUNT SYSTEM
easily unscrew the cork head to mount your camera.

3 YEAR SERVICE

73 cm

CAMERA STAFF

Sizes: packed size: 73 cm adjustable from 115 - 150 cm

Weight: 294 g

Features:

- * detachable camera cork grip with camera mount system
- * Padded trekking strap
- * Aluminum 7075-T6, 3-sections Ø 18/16/14 mm
- * Powerlock 3.0 mechanism
- * MINI-UL VARIO basket
- * tungsten/carbide flex tip

art. # 175 23 49-02



Outdoor

by ISPO

Outstanding Outdoor

Gold Winner 2019

an ISPO Award

3 YEAR SERVICE



CARBON FXP.4 WADING STAFF VARIO

Size: packed size: 43 cm
adjustable from 120 - 140 cm

Weight: 211g

Features:

- * fishing style grip
- * 4-sections:
Carbon, Ø 18/16 mm
- * Powerlock 3.0 mechanism
- * FXP folding mechanism
- * FXP-UL VARIO basket
- * tungsten/carbide flex tip

art. # 196 23 02-10

CAMERA MOUNT SYSTEM
easily unscrew the cork head to mount
your camera.

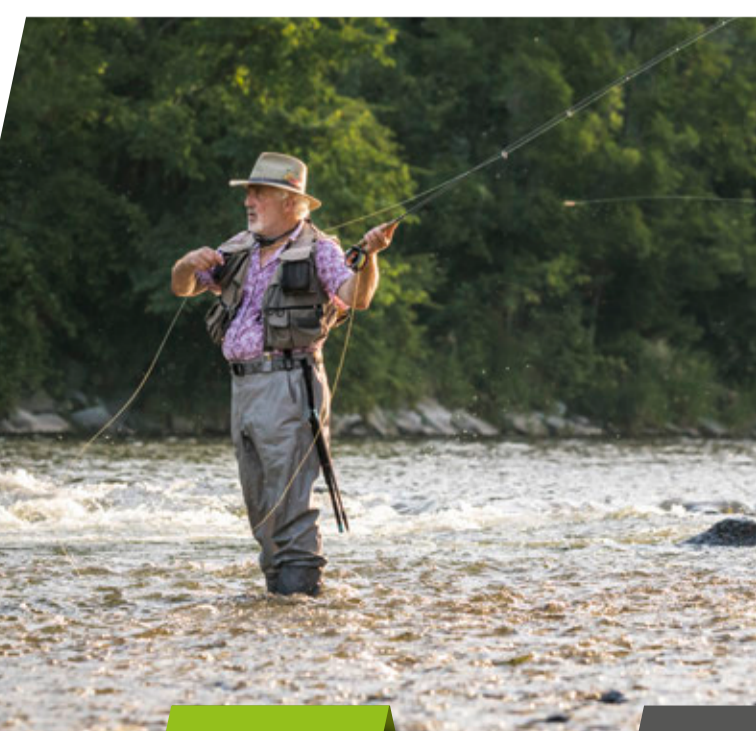

NORDIC WALKING

Our lightest Carbon poles - perfectly balanced and easy to use.



CORK GRIP
comfortable grip feeling, antibacterial

NEW CLICK-IN SYSTEM
much easier to handle and it locks with a distinct *Click*

CARBON FEATHERLIGHT

Sizes: 105 - 135 cm
(in 5 cm steps)

Weight: 148 g (125 cm)

Features:

- * Nordic Walking 2K cork grip
- * Click In strap 2.0
- * Carbon Featherlight tube Ø 16 mm
- * trail tip
- * vulcanised 2-K grip pad

art. # 148 23 19-10

CARBON BAMBOO

Sizes: 105 - 135 cm
(in 5 cm steps)

Weight: 158 g (125 cm)

Features:

- * Nordic Walking 2K cork grip
- * Click In strap 2.0
- * Carbon with Bamboo, Ø 16/9 mm
- * trail tip
- * vulcanised 2-K grip pad

art. # 148 22 01-10

CARBON LIGHT

Sizes: 105 - 135 cm
(in 5 cm steps)

Weight: 173 g (125 cm)

Features:

- * Nordic Walking EVA grip
- * Click In strap 2.0
- * Carbon, Ø 16/9 mm
- * trail tip
- * vulcanised 2-K grip pad

■ art. # 148 23 21-10 black
□ art. # 148 23 20-01 perlmutt

CARBON SPORT

Sizes: 105 - 135 cm
(in 5 cm steps)

Weight: 197 g (125 cm)

Features:

- * Nordic Walking 2K rubber grip
- * Click In strap 2.0
- * Carbon, Ø 16/9 mm
- * trail tip
- * vulcanised 2-K grip pad

■ art. # 148 23 23-10 pink
■ art. # 148 23 22-10 green

NORDIC WALKING

Adjustable Nordic Walking poles - adapt perfectly to every surface and terrain.



3 YEAR SERVICE

86 cm

POWERLOCK 3.0
highly rigid, anodized aluminum for max. holding power!

SPIRIT POWERLOCK

Sizes: packed size: 86 cm
adjustable from 95 - 125 cm

Weight: 201 g

Features:

- * Nordic Walking EVA ultralight grip
- * Click-In strap 2.0
- * aluminum 7075-T6, 2-sections Ø 16/14 mm
- * Powerlock 3.0 mechanism
- * trail tip
- * vulcanised 2-K grip pad

■ art. # 184 23 68-02 blue
■ art. # 184 23 69-02 berry

3 YEAR SERVICE

88 cm

TWISTLOCK
made with glass fiber reinforced plastics

SPIRIT VARIO

Sizes: packed size: 88 cm
adjustable from 95 - 125 cm

Weight: 209 g

Features:

- * Nordic Walking 2K rubber grip
- * Click-In strap 2.0
- * aluminum 7075-T6, 2-sections Ø 16/14 mm
- * Twist Lock mechanism
- * trail tip
- * vulcanised 2-K grip pad

■ art. # 184 23 72-02 green
■ art. # 184 23 73-02 pink

POLE ACCESSORIES ARE ALSO AVAILABLE PRE-PACKED



VARIO SUMMER BASKET
art. # 9356-925



VARIO MINI BASKET
art. # 9907-925



ICE-FLEX BASKET SUMMER
art. # 9397-925



RACE BASKET
art. # 9352-925



RACE BASKET EXTRA SMALL
art. # 9379-925



VARIO DEEP POWDER BASKET
art. # 9908-925



WINTER BASKET
art. # 9351-925



WINTER BASKET XL
art. # 9354-925



ICE-FLEX WINTER BASKET
winter basket: art. # 9396-925
winter basket xl: art. # 9385-925



VARIO WINTER BASKET
art. # 9364-925



VARIO WINTERBASKET XL
art. # 9912-925



NORDIC WALKING PAD
IN DIFFERENT DESIGNS
(COLOR & PIECES) AVAILABLE

- berry: art. # 1007-230-25
- blue: art. # 1007-207-25
- lime: art. # 1007-213-25
- gold: art. # 1007-242-25
- silver: art. # 1007-203-25



TIP PROTECTOR
Ø 8mm: art. # 192-925
Ø 12mm: art. # 190-925



TIP PROTECTOR
Ø 8mm: art. # 162-925
Ø 12mm: art. # 161-925



TRAILSTICK BASKET
art. # 1016-925

EXCHANGEABLE BASKETS FOR VARIO BASKET SYSTEM



VARIO MINI BASKET
Ø 5cm: art. # 9907



VARIO WINTER BASKET
Ø 8,5cm: art. # 9364



VARIO WINTER BASKET XL
Ø 10cm: art. # 9912



VARIO DEEP POWDER BASKET
Ø 13,5cm: art. # 9908

BASKETS FOR ICE-FLEX SYSTEM



ICE-FLEX-SYSTEM
the simply brilliant moveable
basket construction in combi-
nation with our ice-flex-tip



TUBE-COLLAR FOR ICE-FLEX SYSTEM
art. # 146



SUMMER BASKET
Ø 6cm: art. # 9397



WINTER BASKET
Ø 8,5cm: art. # 9396



WINTER BASKET XL
Ø 10cm: art. # 9385



POWDER PE BASKET
Ø 13,5cm: art. # 9391



XC SPEED BASKET
art. # 9384

BASKETS FOR STANDARD TIPS & PLUGS



RACE BASKET
Ø 6cm: art. # 9352



RACE BASKET XS
Ø 5cm: art. # 9379



RACE BASKET XS
Ø 5cm: art. # 9367



WINTER BASKET
Ø 8,5cm: art. # 9351



WINTER BASKET XL
Ø 10cm: art. # 9354



DOWNHILL BASKET
art. # 9383

THE NEW GENERATION OF BASKETS, STRAPS AND PRE-PACKAGING!



NORDIC WALKING CLICK IN 2.0 STRAP

XS: art. # 7014-XS-25
S: art. # 7014-S-25
M: art. # 7014-M-25
L: art. # 7014-L-25



LARGE UL ICE-FLEX BASKET

art. # 9950-925



REGULAR UL ICE-FLEX BASKET

art. # 9949-925



REGULAR UL ICE-FLEX FXP BASKET

art. # 9952-925



MINI UL BASKET

art. # 9942-925



NORDIC SPEED CLICK IN 2.0 STRAP

S: art. # 7012-S-25
M: art. # 7012-M-25
L: art. # 7012-L-25



REGULAR UL BASKET

art. # 9948-925



MINI UL VARIO BASKET

art. # 9943-925



REGULAR UL VARIO BASKET

art. # 9944-925



LARGE UL VARIO BASKET

art. # 9951-925



ICE-FLEX-SYSTEM
the simply brilliant moveable
basket construction in combi-
nation with our ice-flex-tip



TUBE-COLLAR FOR ICE-FLEX SYSTEM

art. # 146



REGULAR UL ICE-FLEX BASKET

Ø 7cm: art. # 9949



REGULAR UL ICE-FLEX FXP BASKET

Ø 7cm: art. # 9952



LARGE UL ICE-FLEX BASKET

Ø 10,5cm: art. # 9950



MINI UL BASKET

Ø 5 cm: art. # 9942



REGULAR UL BASKET

Ø 7cm: art. # 9948



MINI UL VARIO BASKET

Ø 5 cm: art. # 9943



REGULAR UL VARIO BASKET

Ø 7cm: art. # 9944



LARGE UL VARIO BASKET

Ø 10,5cm: art. # 9951

FLEX TIPS FOR VARIO BASKET SYSTEMS



**ICE-FLEX
TUNGSTEN/CARBIDE
TIP**

Ø 9mm, standard version:
art. # 145
Ø 9mm, short version:
art. # 170



**VARIO TUNGSTEN/
CARBIDE FLEX TIP**

Ø 9mm: art. # 178
for POWERLOCK:
Ø 9mm: art. # 166



**VARIO TUNGSTEN/
CARBIDE FLEX
TIP SHORT**

Ø 9mm: art. # 193
for POWERLOCK:
Ø 9mm: art. # 167



**VARIO FLEX
STEEL TIP
LONG**

Ø 9mm: art. # 180



**VARIO FLEX
STEEL TIP
SHORT**

Ø 9mm: art. # 168



**XC VARIO
FLEX TIP**

with steel tip:
Ø 9mm: art. # 110
with Tungsten/Carbide tip:
Ø 9mm: art. # 112



**SHOCK
TIP**

Ø 9mm: art. # 1008



VARIO PLUG
art. # 108

FLEX TIPS FOR STANDARD BASKETS

SITEK
best4grip!



**TUNGSTEN/CARBIDE
FLEX TIP
SHORT**

Ø 9mm: art. # 160



**TUNGSTEN/CARBIDE
FLEX TIP
LONG**

Ø 9mm: art. # 164
with steel tip:
Ø 9mm: art. # 97



XC FLEX TIP

with steel tip:
Ø 9mm: art. # 111



**FLEX
STEEL TIP
SHORT**

Ø 9mm: art. # 96



ALLOY TIP

Ø 9mm
silver: art. # 1024-09
gold: art. # 1024-13
bronze: art. # 1024-25



**BASKET
FIXING
PLUG**

art. # 101



TUBE COLLAR

art. # 100

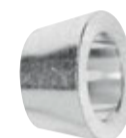

ALLOY PLUG

art. # 106

NORDIC WALKING, TRAIL & WALKER TIPS



**NORDIC WALKING ALL
SEASON TIP**

Ø 9mm: art. # 1001



TRAILSTICK TIP

with tungsten/carbide tip:
Ø 9mm: art. # 1016
with tungsten/carbide hollow tip:
Ø 9mm: art. # 1022



**NORDIC WALKING
SPORT TIP**

with tungsten/carbide tip:
Ø 9mm: art. # 9928



TIP PROTECTOR

Ø 8mm: art. # 192
Ø 12mm: art. # 190



**NORDIC WALKING
SPORT PAD**

for article # 928
Ø 12mm: art. # 128
Ø 12mm without hole: art. # 60
perfect for rollerblading



**NORDIC WALKING
CLASSIC COLOR PAD**

Ø 12mm black: art. # 1007-203

NORDIC TIPS & BASKETS



**NORDIC/BC
TOURING BASKET**

with tungsten/carbide tip:
art. # 9363
with steel tip:
art. # 9375



**NORDIC TREK
ULTRALIGHT BASKET**

holebasket
with tungsten/carbide tip:
Ø 9mm: art. # 9341



**NORDIC TRAIL
ULTRALIGHT BASKET**

with tungsten/carbide tip:
Ø 9mm: art. # 9938



**XC
BASKET**

with tungsten/carbide tip:
art. # 9362
with steel tip:
art. # 9361

ADJUSTING MECHANISM



POWERLOCK 3.0
18/16mm: art. # 1291
16/14mm: art. # 1292



POWERLOCK 2.0
18/16mm: art. # 1277
16/14mm: art. # 1255



POWERLOCK 2.1
18/16mm: art. # 1280
16/14mm: art. # 1282



TUBE COLLAR
Ø 16mm: art. # 1302
Ø 18mm: art. # 1301



COLLAR WITH STOP LOCK
for TITANAL.HF poles
Ø 14mm: art. # 1323
Ø 16mm: art. # 1322
Ø 18mm: art. # 1321



APPROACH 2.0 FASTENER
for Approach: art. # 1226
for Expedition: art. # 1232
for Carbon Ultralight: art. # 1228



THREADED PART
Ø 14mm: art. # 1209
Ø 16mm: art. # 1207



EXPANDING NUT
Ø 14mm: art. # 1210
Ø 16mm: art. # 1208



THREADED PART TITANAL.HF
Ø 12mm: art. # 1270
Ø 14mm: art. # 1272
Ø 16mm: art. # 1274



EXPANDING NUT TITANAL.HF
Ø 12mm: art. # 1271
Ø 14mm: art. # 1273
Ø 16mm: art. # 1275

STRAPS



ALPINE RACE STRAP
art. # 7304



PADDED STRAP
art. # 7342



SYSTEM STRAP
art. # 7307

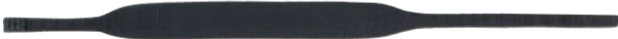

SYSTEM STRAP XL
art. # 7308



LEATHER STRAP
with embossed logo: art. # 7313



JUNIOR STRAP
art. # 7303



STILETTO STRAP
art. # 7314



STANDARD STRAP
art. # 7301



WALKER PADDED STRAP
art. # 7305



POWDER / POWDER PADDED STRAP
Powder art. # 7350
Powder Padded: art. # 7023



STANDARD STRAP ALPINE
art. # 7020



COMFORT / COMFORT PADDED STRAP
Comfort: art. # 7021
Comfort Padded: art. # 7022



NORDIC SPEED CLICK-IN 2.0 STRAP
available in following sizes:
S - M - L
art. # 7012



NORDIC WALKING CLICK-IN 2.0 STRAP
available in following sizes:
XS - S - M - L
art. # 7014



BIATHLON CLICK-IN 2.0 STRAP
available in following sizes:
unisex
art. # 7024

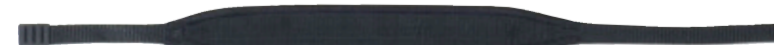

NORDIC PADDED STRAP
art. # 7310



NORDIC CLASSIC STRAP
art. # 7331

NORDIC & NORDIC WALKING STRAPS

ALPINE, TOURING & TREKKING GRIPS



LEATHER GRIP CLASSIC
Ø 16mm: art. # 8854



RACE DUPLO GRIP
Ø 12,3mm: art. # 8073
Ø 13mm: art. # 8079
Ø 16mm: art. # 8549



LIGHTNING DUPLO GRIP
Ø 13mm: art. # 8047



LIGHTNING TOUR DUPLO GRIP
Ø 13mm: art. # 8101



FOAM EXPEDITION SHORT GRIP
Ø 18mm: art. # 8010-02
Ø 20mm: art. # 8166-02



WALKER COMFORT GRIP
Cork:
Ø 16mm: art. # 8773-255
Ø 18mm: art. # 8764-255



FOAM ALPINE GRIP
Ø 13mm: art. # 8847
Ø 16mm: art. # 8810
Ø 18mm: art. # 8784



TOURING GRIP
PE, race Ø 18mm: art. # 8321

TOURING GRIP SYSTEM
rubber, race Ø 18mm: art. # 8179
rubber, race Ø 13mm: art. # 8183
PU, race Ø 18mm: art. # 8180

RACE GRIP RUBBER LIME-GREEN
Ø 16mm: art. # 8264
Ø 18mm: art. # 8818
Ø 19mm: art. # 8233



COMPACT GRIP SYSTEM
PU, Ø 13mm: art. # 8214
PU, Ø 18mm: art. # 8239
PU, Ø 19mm: art. # 8256
PE, Ø 13mm: art. # 8211
PE, Ø 18mm: art. # 8241
Cork, Ø 18mm: art. # 8239-255



COMPACT GRIP STANDARD
PE:
Ø 18mm: art. # 8728
Cork:
Ø 18mm: art. # 8728-255



LADY COMPACT GRIP
PE:
Ø 16mm: art. # 8864
PU:
Ø 16mm: art. # 8874



SABRE GRIP KIDS
Ø 14mm: art. # 8082
Ø 16mm: art. # 8042



JUNIOR JET GRIP
Ø 13mm: art. # 8220
Ø 14mm: art. # 8234
Ø 16mm: art. # 8236



JUNIOR GRIP
PE:
Ø 14mm: art. # 8206
Ø 16mm: art. # 8746
PU:
Ø 16mm: art. # 8734



KIDS RACE GRIP
PE:
Ø 14mm: art. # 8182
Ø 16mm: art. # 8181
PU:
Ø 16mm: art. # 8320



TRAIL 170 GRIP
Ø 18mm: art. # 8136



TREK 170 GRIP
PE - Ø 16mm: art. # 8165
Cork - Ø 18mm: art. # 8130-255
Rubber - Ø 18mm: art. # 8130-2



FOAM 280 GRIP
Ø 18mm: art. # 8135



PISTOL 2K GRIP
Ø 13mm: art. # 8317
Ø 16mm: art. # 8318
Ø 18mm: art. # 8319



2K TOURING FOAM 280 GRIP
Ø 16mm: art. # 8306
Ø 18mm: art. # 8307



2K TOURING FOAM 450 GRIP
Ø 16mm: art. # 8308
Ø 18mm: art. # 8309



FOAM PISTOL 120 GRIP
Ø 13mm: art. # 8313
Ø 16mm: art. # 8314
Ø 18mm: art. # 8315

NORDIC & NORDIC WALKING GRIPS



NORDIC 2K CLICK-IN 2.0 GRIP
Ø 16mm: art. # 8184



NORDIC 2K CLICK-IN 2.0 GRIP
Ø 16mm, FOAM: art. # 8177



NORDIC INJECTED CLICK-IN GRIP
Ø 16mm: art. # 8895



XC GRIP
without CLICK-IN
FOAM:
Ø 16mm: art. # 8721
Ø 18mm: art. # 8738
DUPL0:
Ø 16mm: art. # 8213



XC ULTRALIGHT FOAM GRIP
with CLICK-IN
Ø 16mm: art. # 8805



XC CLASSIC GRIP
PE:
Ø 16mm: art. # 8004-02
Cork:
Ø 16mm: art. # 8004-225

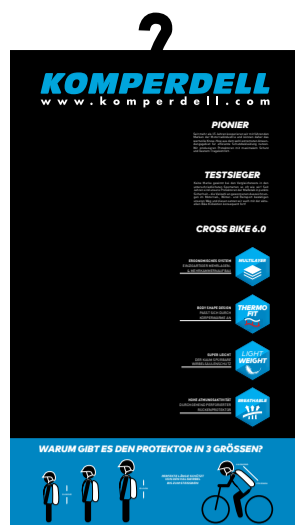

PROTECTION BIKE DEMO BOARD

- Features:**
- ★ 55x90 cm
 - ★ Kapa material 5 mm
 - ★ removable protector insert
 - ★ with optional hook to fix on cloth rail

art. # 6261-207



DEMO BALLISTIC VEST ON TORSO

- Features:**
- ★ technique of the Ballistic Vest
 - ★ consists of torso, Ballistic Vest and Pro Short

art. # 6254-206

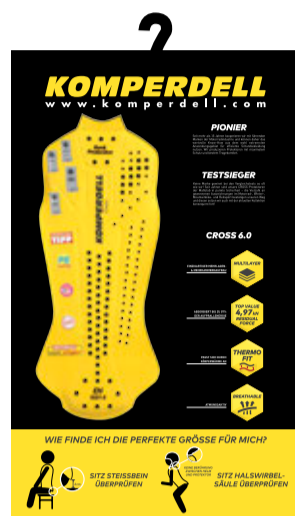

PROTECTION SKI DEMO BOARD

- Features:**
- ★ 55x90 cm
 - ★ Kapa material 5 mm
 - ★ removable protector insert
 - ★ with optional hook to fix on cloth rail

art. # 6256-206



DISPLAY MANNEQUINS & TORSI

- Males mannequin: art. # 2080-99
Ladies mannequin: art. # 2081-99
Junior mannequin: art. # 2082-99
Male torso: art. # 2083-99
Female torso: art. # 2084-99



LOGO BANNER

- Features:**
- ★ 200x70 cm
 - ★ fully eyed and sealed outside
 - ★ ideal for promotion to hang into the shop, in the window, on fences etc.

- art. # 35-48
- art. # 35-29



ENG



DE



POLE DISPLAY

- Features:**
- ★ Instore display for Trekking- and Alpine poles
 - ★ made of robust aluminum
 - ★ with wheels
 - ★ perfect for any shop
 - ★ includes 12 pegs

art. # 56-999



DISPLAY HENRIK KRISTOFFERSEN

- Features:**
- ★ life-sized shop display
 - ★ 190 cm height
 - ★ real poles to be fixed on the display
 - ★ poles not included in the price

art. # 54-999



POLE DISPLAY MADE OF MASSIV WOOD

- Features:**
- ★ for 16 pairs of poles (without poles)
 - ★ for 8 pairs of poles (without poles)
- art. # 181-25
art. # 431-25



POLE DISPLAY MADE OF STONE

- Features:**
- ★ with illuminated logo
 - ★ for 10 pairs of poles (without poles)
- art. # 38-999



POLE PACKAGING

- Ø 14mm: art. # 2301-14
- Ø 16mm: art. # 2301-16
- Ø 18mm: art. # 2301-18



BEACHFLAGS

- Features:**
- ★ lined transportation bag
 - ★ bottom board 18x30x0,6 cm for inside use or ground pin for outdoor use
- total height 250cm
total height 450cm
- art. # 34-48
 - art. # 35-48
 - art. # 34-29
 - art. # 35-29



HEADQUARTERS MONDSEE

KOMPERDELL GmbH

Wagnermühle 30

5310 Mondsee • Austria

phone: +43/6232/4201-0

fax: +43/6232/3545

e-mail: sales@komperdell.com

www.komperdell.com

DISTRIBUTION NORTH AMERICA

CAMARO USA, LLC

22737 72nd Avenue S, Suite C-103

Kent, WA 98032 • USA

phone: +1 253-867-57 35

fax: +1 253-867-57 34

e-mail: sales-usa@camaro.at

www.komperdell.com

KOMPERDELL
www.komperdell.com



[komperdell.outdoor.sport](https://www.facebook.com/komperdell.outdoor.sport)



[komperdell_official](https://www.instagram.com/komperdell_official)



[Komperdell](https://www.youtube.com/Komperdell)